

KombiSIGN 71 / Audible Devices 645
Siren element 8 tne 230VAC BK

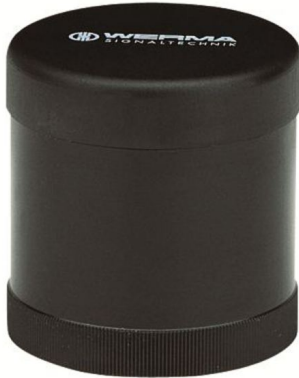

Part No.:	645.820.68
Series:	KombiSIGN 71



MECHANICAL DATA	
Height	72 mm
Diameter	70 mm
Materials	PC
Housing colour	Black
Protection category	IP65
Service life optical	5,000 h minimum
Acoustic service life	5,000 h minimum
Working temperature minimum	-20°C
Working temperature maximum	+50°C
UL Type Rating	Type 12
Weight with packaging	102 g
Product weight	87 g

ELECTRICAL DATA	
Operating voltage	230V
Operating voltage type	AC
Operating voltage type	50Hz
Operating voltage tolerance	+/- 10%
Rated operational voltage	230 VAC
Rated operational current	40 mA
Protection class	Protection class 2
Pollution degree	3
Overvoltage category	II
Isolation voltage	Ui = 250V; Uimp = 2.500V



For additional installation and mounting information, refer to the appropriate user guide at www.werma.com. This printed copy is for information only and is subject to alteration.

KombiSIGN 71 / Audible Devices 645

Siren element 8 tne 230VAC BK

DRAWING

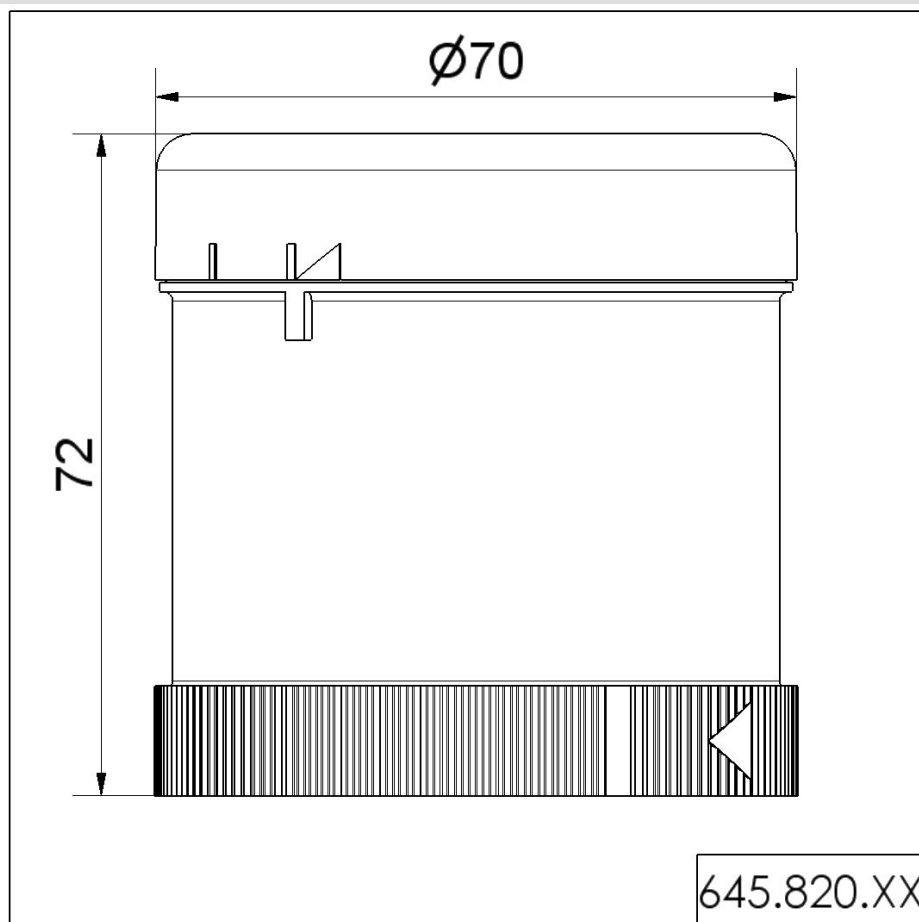

For additional installation and mounting information, refer to the appropriate user guide at www.werma.com. This printed copy is for information only and is subject to alteration.