



Handbuch | WERMA - Konfigurationssoftware
Manual | WERMA - Configuration Software
手册 | WERMA - 配置软件

Version: 3.0 - 10/2024

310.657.006

Deutsch	5
English	93
中文 (中国)	181



Handbuch

WERMA - Konfigurationssoftware

Version: 3.0 - 10/2024

310.657.006

Impressum

Jegliche Erwähnung von Firmennamen dient ausschließlich zu Instruktionzwecken. Eine Bezugnahme auf tatsächlich existierende Organisationen ist, bis auf die unten stehenden Ausnahmen, nicht beabsichtigt. Folgende Firmen und Marken werden in der Hilfe genannt:

- Microsoft Windows 10 und Windows 11 sind Marken der Microsoft Corporation.

Irrtum, Druckfehler und technische Änderungen vorbehalten.

© Copyright 2024, WERMA Signaltechnik GmbH + Co.KG.

Alle Rechte vorbehalten.

WERMA Signaltechnik GmbH + Co.KG

D-78604 Rietheim-Weilheim

Fon: +49 (0)7424 / 9557-222

Fax: +49 (0)7424 / 9557-44

support@werma.com

www.werma.com

Inhaltsverzeichnis

1 Überblick	9
1.1 Funktion	9
1.2 Systemanforderungen	9
2 WERMA - Konfigurationssoftware installieren	10
3 WERMA - Konfigurationssoftware starten	10
4 eSIGN konfigurieren	11
4.1 Funktion	11
4.2 Hardware-Beschreibung	11
4.2.1 Übersicht Anschlussbereich	12
4.2.2 Übersicht M12-Stecker 8-polig	13
4.3 Überblick	14
4.3.1 Bereich Konfiguration	15
4.3.2 Bereich Geräteinformation	15
4.3.3 Bereich Support	15
4.3.4 Bereich Diese Software	15
4.3.5 Bereich Firmware	15
4.4 Sprache einstellen	15
4.5 Neue Konfiguration erstellen	16
4.5.1 Modus Autoscale	18
4.5.2 Modus Signalsäule	28
4.5.3 Modus Füllstand	38
4.5.4 Modus Individual	52
4.6 Konfiguration aus Beispielvorgängen übernehmen	65
4.7 Konfiguration von der angeschlossenen eSIGN laden	67
4.8 Bestehende Konfiguration öffnen	68
4.9 Firmware aktualisieren	69
5 MC55 Touch S konfigurieren	70
5.1 Funktion	70
5.2 Hardware-Beschreibung	70
5.2.1 Übersicht Anschlussbereich	70
5.2.2 Übersicht M12-Stecker 5-polig	71
5.2.3 Standardeinstellung	71
5.3 Überblick	72
5.3.1 Bereich Konfiguration	73
5.3.2 Bereich Geräteinformation	73
5.3.3 Bereich Support	73
5.3.4 Bereich Diese Software	73
5.3.5 Bereich Firmware	73

5.4 Sprache einstellen	73
5.5 Neue Konfiguration erstellen	74
5.5.1 Signaleingang wählen	76
5.5.2 Modus ändern	77
5.5.3 Zustände anpassen	79
5.5.4 Farbe wählen	80
5.5.5 Leuchteffekt wählen	81
5.5.6 Sirene wählen	82
5.5.7 Zeitbasierte Eskalation anpassen	83
5.5.8 Ausgang aktivieren	85
5.5.9 Ansteuerung simulieren	86
5.5.10 Konfiguration abschließen	86
5.6 Konfiguration aus Beispielvorlagen übernehmen	87
5.7 Konfiguration vom angeschlossenen MC55 Touch S laden	89
5.8 Bestehende Konfiguration öffnen	90
5.9 Firmware aktualisieren	90
6 WERMA - Konfigurationssoftware aktualisieren	91
7 Support	92

1 Überblick

1.1 Funktion

Mit der WERMA - Konfigurationssoftware können folgenden WERMA-Geräte konfiguriert werden:

- eSIGN Signalsäule
- MC55 Touch S

 Die zur Verfügung stehenden Geräte sind marktabhängig.

1.2 Systemanforderungen

Betriebssystem	Windows 10 x86/x64 Windows 11 Aktuelle Windows-Updates werden vorausgesetzt.
USB-Anschluss	Notwendig für die Hardware-Konfiguration.

 Unterstützte Betriebssysteme werden nur solange unterstützt, wie auch Microsoft diese über den Microsoft-Support Lifecycle unterstützt.

2 WERMA - Konfigurationssoftware installieren

Die WERMA - Konfigurationssoftware muss nicht installiert werden und ist als Portable lauffähig.

1. WERMA - Konfigurationssoftware von folgender Webseite herunterladen:
www.werma.com/software.

3 WERMA - Konfigurationssoftware starten

1. Auf Werma-Konfigurator.exe doppelklicken.
→ Die WERMA - Konfigurationssoftware startet.



2. Gewünschtes Gerät wählen.

4 eSIGN konfigurieren

4.1 Funktion

Mit der neuen eSIGN bringen wir Licht in neue Dimensionen. Dank elektrischer Modularität lassen sich verschiedene Signalisierungsmodi mit mehreren Farben, Helligkeitsstufen und Leuchtbildern realisieren: Von der klassischen Ampel bis hin zu komplett kundenspezifischen Einstellungen. Auch variable Füllstandanzeigen oder vollflächige Signalisierungen sind mit eSIGN problemlos realisierbar. Das bringt nicht nur Übersicht in Ihre Prozessabläufe, sondern eröffnet ganz neue Möglichkeiten.

Mit Hilfe der WERMA - Konfigurationssoftware können die einzelnen Segmente einer WERMA eSIGN konfiguriert und die Konfiguration auf die eSIGN übertragen werden.

Die Konfiguration kann mit oder ohne angeschlossener eSIGN durchgeführt werden. Falls keine eSIGN angeschlossen wird, kann die Konfiguration in einer Konfigurationsdatei gespeichert und zu einem späteren Zeitpunkt geladen und auf eine angeschlossene eSIGN übertragen werden.

4.2 Hardware-Beschreibung

Die Informationen zur Hardware gelten für folgende Artikelnummern:

- 657.0x0.55 & 657.2x0.55 - 9 Segmente
- 657.1x0.55 & 657.3x0.55 - 9 Segmente mit Sirene
- 657.5x0.55 & 657.7x0.55 - 15 Segmente
- 657.6x0.55 & 657.8x0.55 - 15 Segmente mit Sirene

4.2.1 Übersicht Anschlussbereich

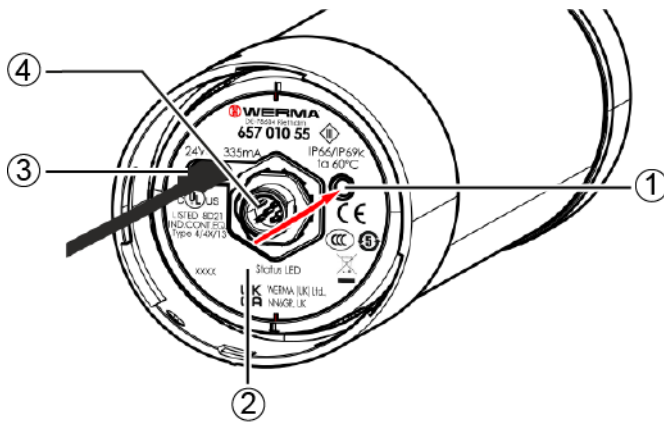

Pos.	Beschreibung
1	User-Button
2	Status-LED
3	USB-C-Anschluss
4	M12-Stecker 8-polig

LED-Status	Beschreibung
LED blinkt gelb	Normaler Betrieb
LED pulsiert	Firmware-Update wird aufgespielt
LED ist aus	USB-C-Kabel nicht richtig verbunden

i Der User-Button ist in der aktuellen eSIGN-Version ohne Funktion und wird für zukünftige Funktionserweiterungen bereitgehalten.

4.2.2 Übersicht M12-Stecker 8-polig

Der Anschluss der eSIGN erfolgt über einen 8-poligen M12-Stecker mit folgender Belegung:

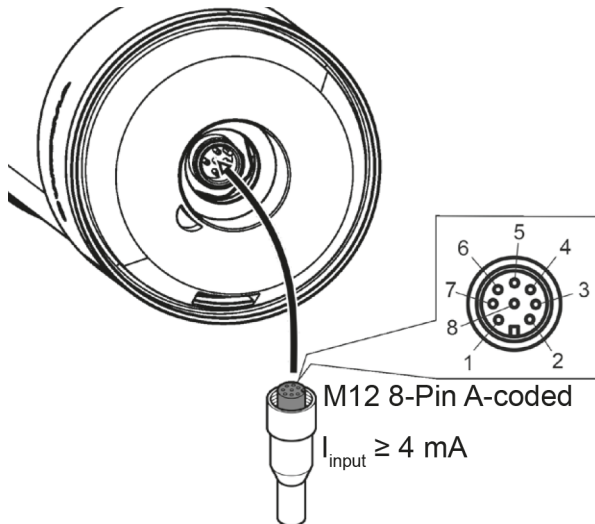

M12 Pinbelegung	Litzenfarbe M12- Kabel	Funktion
1	weiß	Signal 1
2	braun	Signal 2
3	grün	Signal 3
4	gelb	Signal 4
5	grau	Signal 5
6	rosa	Signal 6
7	blau	COM
8	rot	+24V

4.3 Überblick

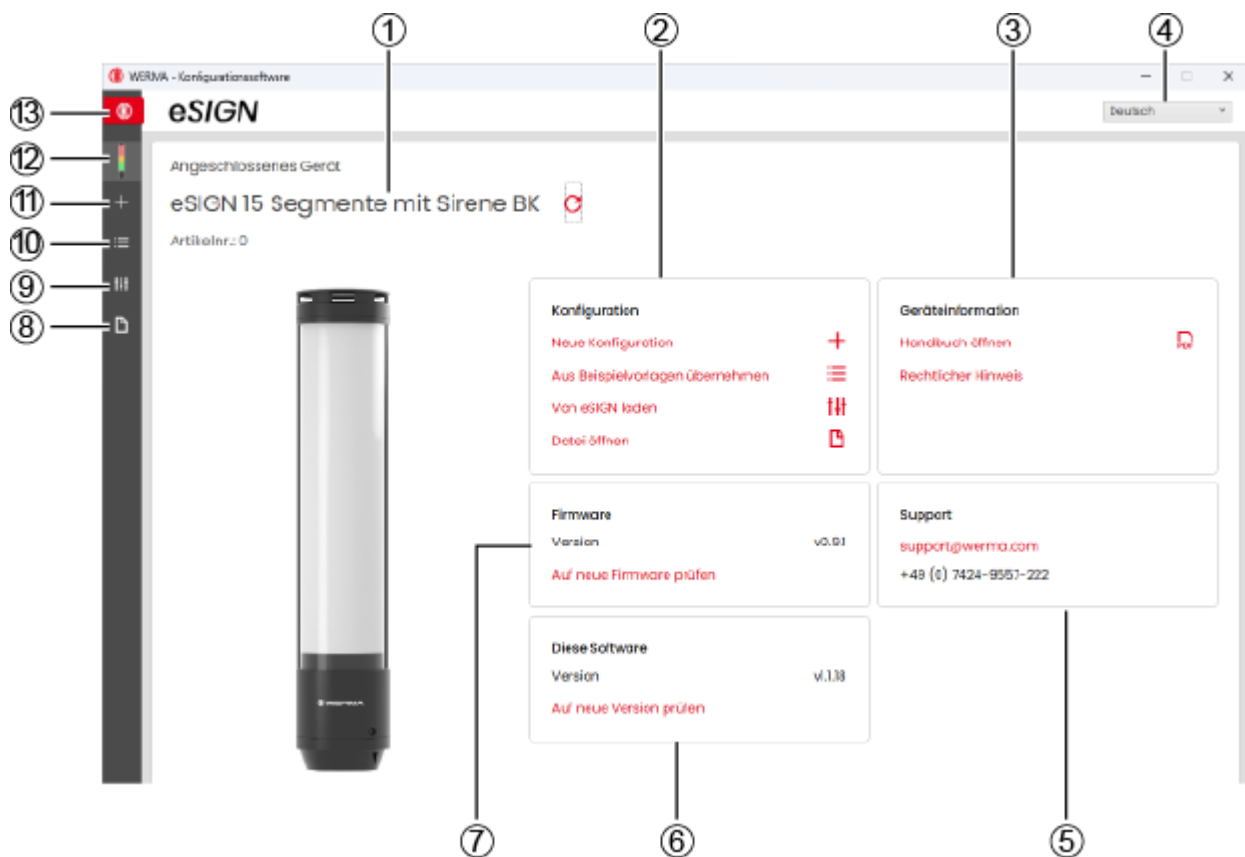

Pos.	Beschreibung
1	Variante der angeschlossenen eSIGN
2	Bereich Konfiguration
3	Bereich Geräteinformation
4	Sprache einstellen
5	Bereich Support
6	Bereich Diese Software
7	Bereich Firmware
8	Bestehende Konfiguration öffnen
9	Konfiguration von der eSIGN laden
10	Konfiguration aus Beispielvorlagen übernehmen
11	Neue Konfiguration erstellen
12	Startbildschirm aufrufen
13	Geräteauswahl

4.3.1 Bereich Konfiguration

Im Bereich **Konfiguration** gibt es folgende Möglichkeiten, eine Konfiguration vorzunehmen:

- **Neue Konfiguration:** Eine neue Konfiguration erstellen (siehe "Neue Konfiguration erstellen", S. 16).
- **Aus Beispielvorlagen übernehmen:** Standard-Vorlagen öffnen, die sofort auf das Gerät überspielt werden können (siehe "Konfiguration aus Beispielvorlagen übernehmen", S. 65).
- **Von eSIGN laden:** Aktuelle Konfiguration (ggf. Auslieferungszustand) zur Bearbeitung öffnen (siehe "Konfiguration von der angeschlossenen eSIGN laden", S. 67).
- **Datei öffnen:** Eine bestehende Konfiguration öffnen und wiederverwenden (siehe "Bestehende Konfiguration öffnen", S. 68).

4.3.2 Bereich Geräteinformation

Im Bereich **Geräteinformation** können das Handbuch und rechtliche Hinweise aufgerufen werden.

4.3.3 Bereich Support

Im Bereich **Support** werden die Kontaktinformationen des WERMA-Supports angezeigt.

4.3.4 Bereich Diese Software

Im Bereich **Diese Software** wird der Versionsstand der WERMA - Konfigurationssoftware angezeigt und eine Möglichkeit zur Aktualisierung der Konfigurationssoftware angeboten.

4.3.5 Bereich Firmware

Im Bereich **Firmware** werden Informationen zur Firmware der angeschlossenen eSIGN angezeigt und eine Möglichkeit zur Aktualisierung der Firmware angeboten.

4.4 Sprache einstellen

1. Im Auswahlménü die gewünschte Sprache wählen.

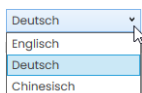

4.5 Neue Konfiguration erstellen

 Die Konfiguration kann mit oder ohne angeschlossener eSIGN durchgeführt werden.

 Die eSIGN kann gleichzeitig per USB-Kabel mit einem Computer und mit der 24-V-Stromversorgung über das M12-Kabel verbunden werden.

1. eSIGN per USB-Kabel an Computer anschließen.

→ Die WERMA - Konfigurationssoftware erkennt die angeschlossene eSIGN.

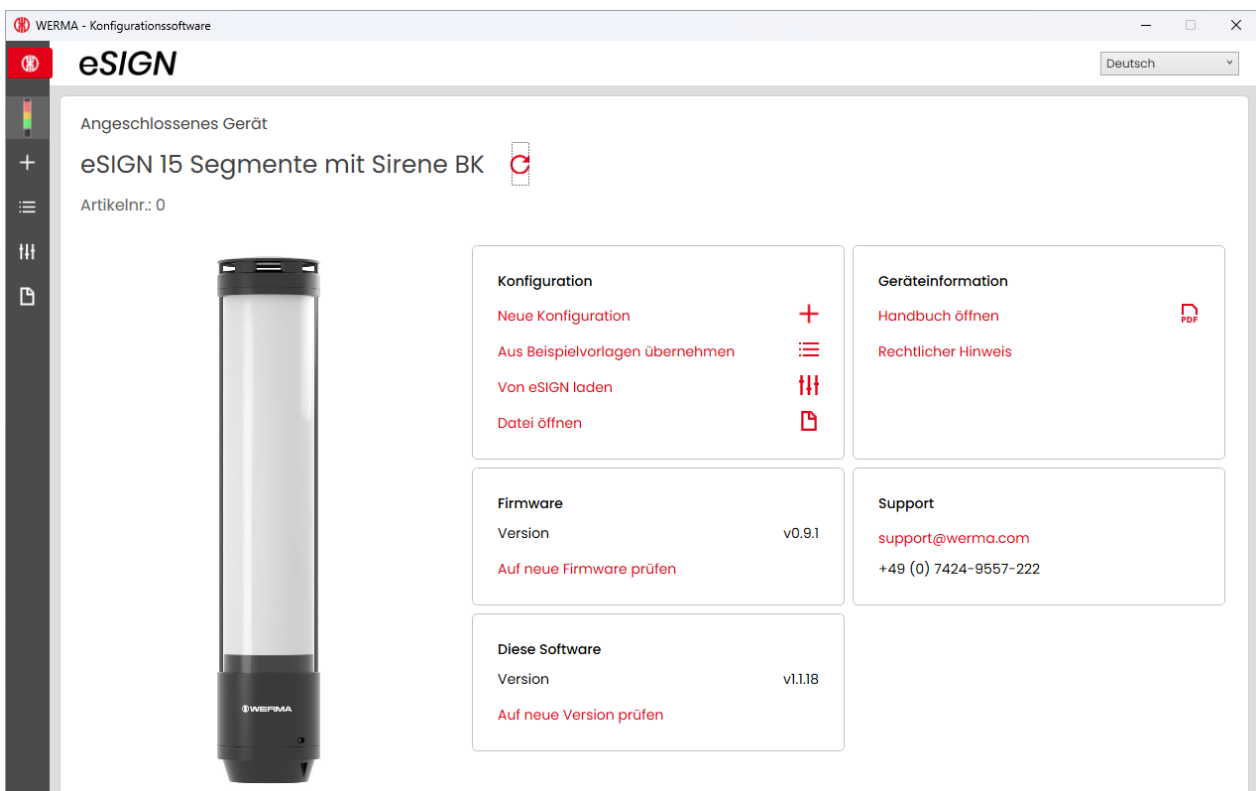

2. Falls die WERMA - Konfigurationssoftware die angeschlossene eSIGN nicht erkennt: Auf **Angechlossenes Gerät aktualisieren** klicken.

kein Gerät verbunden 

3. Im Bereich **Konfiguration** auf **Neue Konfiguration** klicken.

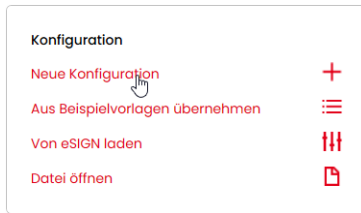

→ Der Bildschirm **Neue Konfiguration erstellen** erscheint.

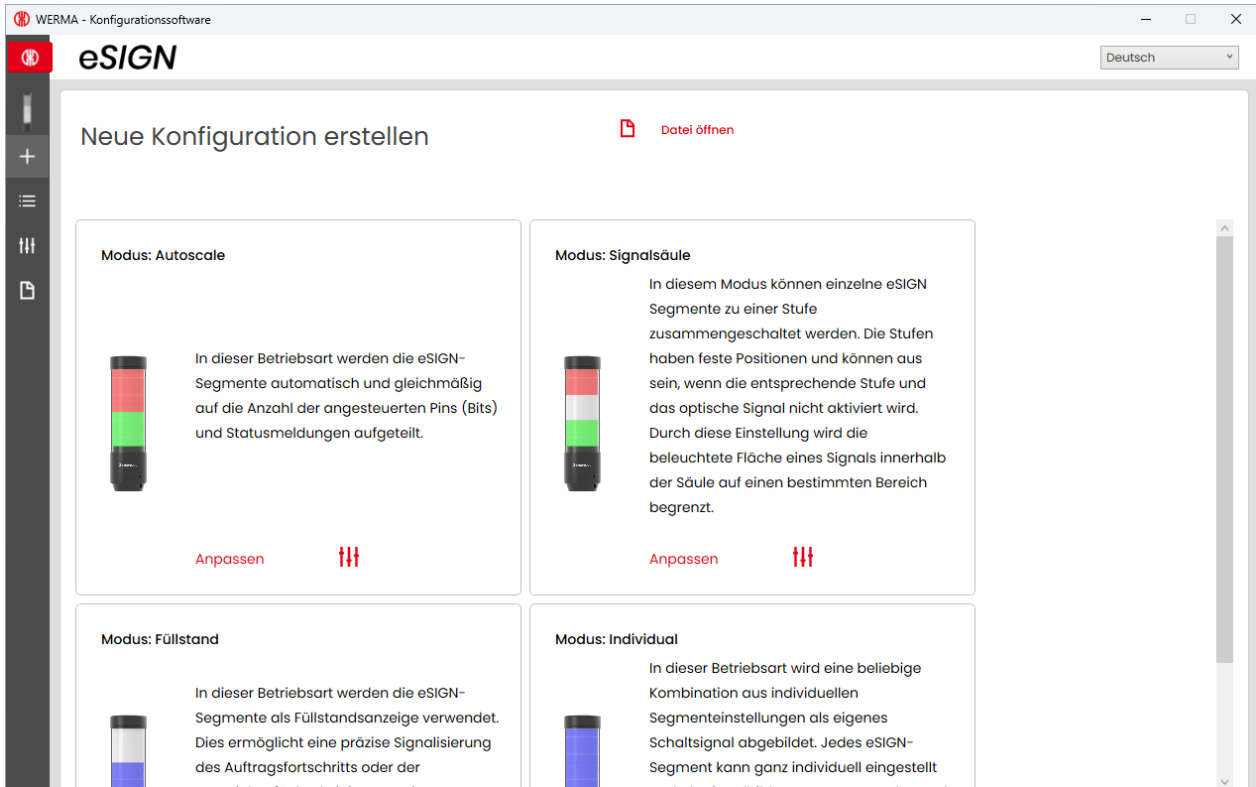

4. Je nach gewünschtem Konfigurationsmodus im Bereich **Modus: Autoscale**, **Modus: Signalsäule**, **Modus: Füllstand** oder **Modus: Individual** auf **Anpassen** klicken.



4.5.1 Modus Autoscale

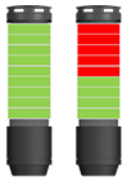

Die eSIGN-Segmente werden automatisch und gleichmäßig auf die Anzahl der angesteuerten Pins (Bits) und Statusmeldungen aufgeteilt.

Mit dieser Einstellung kann das volle Potenzial der eSIGN durch eine vollflächige Signalisierung ausgeschöpft werden. Ist z. B. nur eine Statusmeldung aktiv, wird die gesamte Fläche der eSIGN einfarbig beleuchtet, um eine maximale Sichtbarkeit zu gewährleisten.

Bei Anliegen von mehreren Signalen wird die beleuchtete Fläche anteilig aufgetrennt. Können die Segmente nicht gleichmäßig aufgeteilt werden, erhält die Farbe mit der höchsten Priorität (höchste Stelle innerhalb der Säule) das letzte Segment. Falls mehrere Segmente übrig sind, werden diese der Priorisierung nach (die Positionierung in der Säule von oben nach unten) gleichmäßig verteilt.

Pos.	Farbe	Leuchteffekt	Helligkeit	Sirene	Pin
×	Red	Dauerlicht	Slider		Pin 3: Signal 3
+	Orange	Dauerlicht	Slider		Pin 2: Signal 2
×	Green	Dauerlicht	Slider		Pin 1: Signal 1
+					



Bei Bedarf kann die Ausrichtung der dargestellten Signalsäule über die Schaltfläche **Montagerichtung wechseln** um 180° gedreht werden.

- i** Bei Bedarf (z. B. um die Strombegrenzungen von Steuerungsausgängen berücksichtigen zu können) kann über die Schaltfläche **Strombegrenzung** die Leistungsaufnahme der eSIGN verringert werden. In diesem Fall wird der Strombedarf der Säule auf unter 500 mA reduziert. Als Folge wird die Helligkeit der optischen Signale bzw. die Lautstärke der akustischen Signale verringert.

Der Modus **Autoscale** ist die Standard-Betriebsart bei Auslieferung und wie folgt eingestellt:

- Varianten mit 9 Segmenten:
 - 3 Stufen rot/gelb/grün
 - Dauerlicht
- Varianten mit 15 Segmenten:
 - 5 Stufen rot/gelb/grün/weiß/blau
 - Dauerlicht

Bei kundenindividuellen Versionen weicht der Auslieferungszustand von diesem Standard ab und ist gesondert dokumentiert.

4.5.1.1 eSIGN-Variante wählen

Falls eine eSIGN angeschlossen wurde, ist die Variante entsprechend vorausgewählt. Falls keine eSIGN angeschlossen wurde, kann die Variante der zu konfigurierenden eSIGN gewählt werden.

1. Bei Bedarf die Variante der zu konfigurierenden eSIGN wählen.

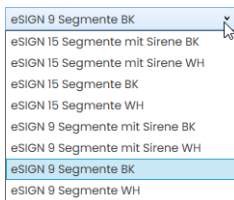

4.5.1.2 Stufe hinzufügen oder entfernen

Sobald im Modus **Autoscale** eine Stufe hinzugefügt oder entfernt wird, werden die einzelnen eSIGN-Segmente automatisch neu aufgeteilt und gleichmäßig auf alle Stufen verteilt. Falls die Segmente nicht gleichmäßig aufgeteilt werden können, erhält die Farbe mit der höchsten Priorität (höchste Stelle innerhalb der Säule) das letzte Segment. Falls mehrere Segmente übrig sind, werden diese der Priorisierung nach (die Positionierung in der Säule von oben nach unten) gleichmäßig verteilt.

Stufe hinzufügen

1. Auf **Hinzufügen** klicken.



×

→ Eine Stufe wurde hinzugefügt.

Stufe entfernen

1. Auf **Entfernen** klicken.



→ Eine Stufe wurde entfernt.

4.5.1.3 Stufe verschieben

Bei Bedarf können die einzelnen Stufen nach oben oder unten verschoben werden.

1. In der Spalte **Pos.** auf den Pfeil nach oben oder auf den Pfeil nach unten klicken, um die Stufe nach oben bzw. nach unten zu verschieben.



4.5.1.4 Farbe wählen

Jeder Stufe kann eine vorgegebene Standardfarbe oder eine individuelle Farbe zugewiesen werden.

1. In der Spalte **Farbe** auf das Farbfeld klicken.



→ Das Fenster **Farbe auswählen** erscheint.



2. Wählen, ob eine Standardfarbe oder eine individuelle Farbe verwendet werden soll.

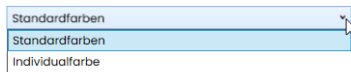

Standardfarbe

1. Auf das gewünschte Farbfeld klicken.



Folgende 8 Standardfarben stehen zur Verfügung:

- rot
- gelb
- grün
- weiß
- blau
- hellgelb
- violett
- türkis

Individualfarbe

1. Gewünschte Farbe im Farbfeld auswählen oder den entsprechenden RGB-Wert in den Feldern **Rot**, **Grün** und **Blau** eingeben.

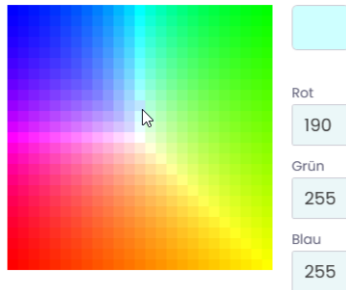

2. Auf **Farbe auswählen** klicken.



4.5.1.5 Leuchteffekt wählen

1. In der Spalte **Leuchteffekt** den gewünschten Leuchteffekt wählen.

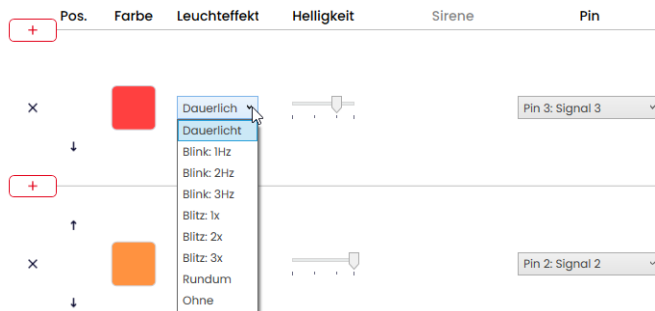

Folgende 8 Leuchteffekte stehen zur Verfügung:

- Dauerlicht
- Blink 1Hz
- Blink 2Hz
- Blink 3Hz
- Blitz 1x
- Blitz 2x
- Blitz 3x
- Rundum
- Ohne



Die Einstellung **Ohne** kann gewählt werden, falls die Stufe nur mit Sirene belegt werden soll.

4.5.1.6 Helligkeit einstellen

1. In der Spalte **Helligkeit** aus den 4 Optionen die gewünschte Helligkeit der Stufe einstellen.

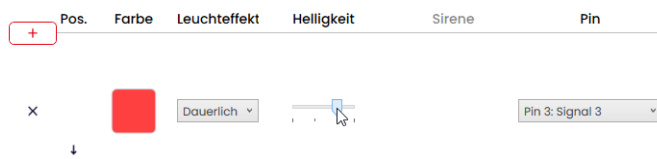

4.5.1.7 Sirene wählen

Falls die angeschlossene oder gewählte eSIGN eine Sirene hat, kann ein Signalton gewählt werden, der bei Aktivierung der Stufe ertönt.

i Falls Signaltöne für mehrere Stufen hinterlegt und die Stufen gleichzeitig angesteuert werden, ertönt die Sirene für die Farbe mit der höchsten Priorität (höchste Stelle innerhalb der Säule).

1. In der Spalte **Sirene** auf **Kein Ton** klicken.





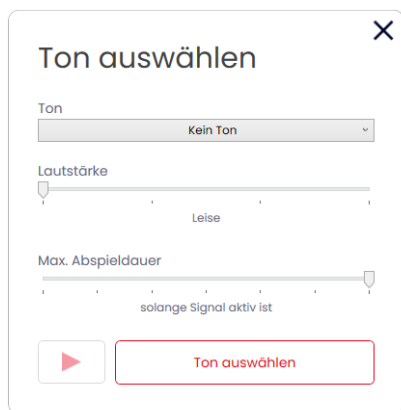



→ Das Fenster **Ton auswählen** erscheint.

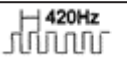
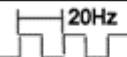

2. Den gewünschten **Ton**, die gewünschte **Lautstärke** und **Max. Abspieldauer** wählen.

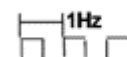
Folgende 10 Tonarten stehen zur Verfügung:

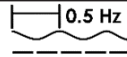
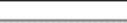
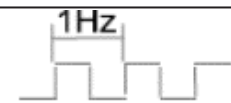
Ton	Frequenz	Beschreibung	Max. dB (A)
1	 2.7 kHz	Dauerton	104
2	 0.9 kHz	Dauerton	96
3	 2.8 kHz	Pulston	97
4	 0.9 kHz	Pulston	93
5	 2.8 kHz	Pulston	103
6	 0.9 kHz	Pulston	96
7	 2.8 kHz	Pulston	104
8	 2.3 kHz- 3.6 kHz	Wobbelton	104
9	 2.6 kHz	Dauerton	105
10	 1200 Hz 800 Hz	Wechselton	92



Der gewählte Ton kann über die Schaltfläche ► in der Tonauswahl getestet werden. Der Ton wird dabei über den Computer abgespielt.

3. Auf **Ton auswählen** klicken.

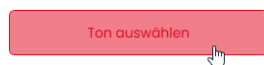

4.5.1.8 Pin wählen



Die Felder sind mit einer Standardbelegung vorkonfiguriert, von der unteren Stufe der Säule beginnend mit Pin 1.

Bereits verwendete Pins werden grau dargestellt. Die Belegung kann bei Bedarf beliebig verändert werden.

1. In der Spalte **Pin** den Pin des 8-poligen Steckers wählen, auf dem das Signal zum Auslösen der Stufe gesendet wird.

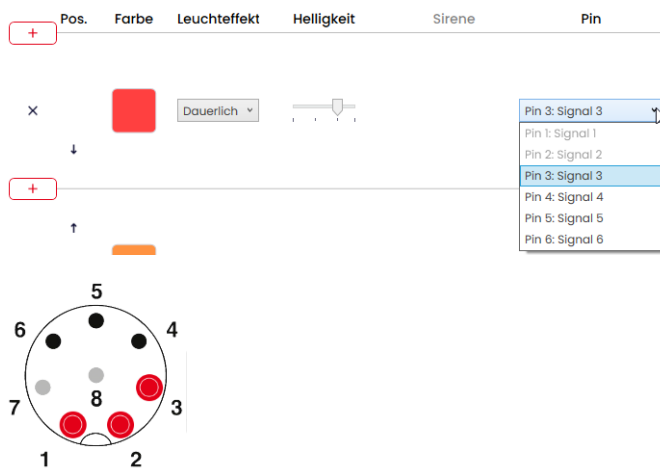

Pin-Konfiguration anpassen

Bei Bedarf kann die Zuordnung der Litzenfarbe zum Pin geändert und eine Beschreibung des Signals hinterlegt werden.

1. Unter der Pin-Übersicht auf **PIN Konfiguration** klicken.

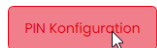

→ Das Fenster **PIN Konfiguration** erscheint.

PIN Konfiguration ✕

	Farbe	Beschreibung
Pin 1: Signal 1	WH	
Pin 2: Signal 2	BN	
Pin 3: Signal 3	GN	
Pin 4: Signal 4	YE	
Pin 5: Signal 5	GY	
Pin 6: Signal 6	PK	
Pin 7: COM	BU	
Pin 8: +24V	RD	

Speichern

2. In der Spalte **Farbe** die gewünschte Litzenfarbe eingeben.
3. In der Spalte **Beschreibung** die Beschreibung des Signals eingeben.
4. Auf **Speichern** klicken.

4.5.1.9 Ansteuerung simulieren

Nachdem alle Einstellungen vorgenommen wurden, kann die Ansteuerung simuliert werden.

1. In der Pin-Übersicht auf den Pin klicken, der die gewünschte Stufe aktivieren soll.

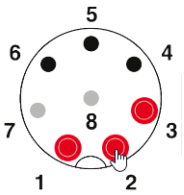

4.5.1.10 Konfiguration abschließen

1. Bei Bedarf weitere Änderungen an der Konfiguration vornehmen.
2. Sobald alle Stufen wie gewünscht konfiguriert sind, auf **Abschließen** klicken.
→ Das Fenster **Abschließen** erscheint.



3. Auf **Speichern** klicken, um die Konfiguration in einer Konfigurationsdatei zu speichern.
4. Auf **Auf Gerät übertragen** klicken, um die Konfiguration auf die angeschlossene eSIGN zu übertragen.
5. Auf **PDF-Konfigurationsblatt anzeigen** klicken, um eine Übersicht der aktuellen Konfiguration anzuzeigen.
6. Auf **PDF-Konfigurationsblatt speichern** klicken, um die Übersicht der aktuellen Konfiguration als PDF-Datei zu speichern.

4.5.2 Modus Signalsäule

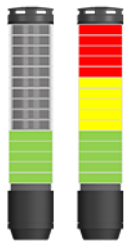

Einzelne eSIGN-Segmente können zu einer Stufe zusammengeschaltet werden.

Dadurch kann eine klassische Signalsäule in elektronisch modularer Form realisiert werden. In diesem Modus haben die Stufen feste Positionen und können aus sein, wenn die entsprechende Stufe und das optische Signal nicht aktiviert werden.

Durch diese Einstellung wird die beleuchtete Fläche eines Signals innerhalb der Säule auf einen bestimmten Bereich begrenzt.

Pos.	Farbe	Leuchteffekt	Helligkeit	Sirene	Pin
+	Red	Dauerlicht	...		Pin 3: Signal 3
+	Orange	Dauerlicht	...		Pin 2: Signal 2
+	Green	Dauerlicht	...		Pin 1: Signal 1

i Bei Bedarf kann die Ausrichtung der dargestellten Signalsäule über die Schaltfläche **Montagerichtung wechseln** um 180° gedreht werden.

i Bei Bedarf (z. B. um die Strombegrenzungen von Steuerungsausgängen berücksichtigen zu können) kann über die Schaltfläche **Strombegrenzung** die Leistungsaufnahme der eSIGN verringert werden. In diesem Fall wird der Strombedarf der Säule auf unter 500 mA reduziert. Als Folge wird die Helligkeit der optischen Signale bzw. die Lautstärke der akustischen Signale verringert.

4.5.2.1 eSIGN-Variante wählen

Falls eine eSIGN angeschlossen wurde, ist die Variante entsprechend vorausgewählt. Falls keine eSIGN angeschlossen wurde, kann die Variante der zu konfigurierenden eSIGN gewählt werden.

1. Bei Bedarf die Variante der zu konfigurierenden eSIGN wählen.



4.5.2.2 Stufe hinzufügen oder entfernen

Sobald im Modus **Signalsäule** eine Stufe hinzugefügt oder entfernt wird, werden die einzelnen eSIGN-Segmente automatisch neu aufgeteilt und gleichmäßig auf alle Stufen verteilt.

Stufe hinzufügen

1. Auf **Hinzufügen** klicken.



x

→ Eine Stufe wurde hinzugefügt.

Stufe entfernen

1. Auf **Entfernen** klicken.



→ Eine Stufe wurde entfernt.

4.5.2.3 Stufe verschieben

Bei Bedarf können die einzelnen Stufen nach oben oder unten verschoben werden.

1. In der Spalte **Pos.** auf den Pfeil nach oben oder auf den Pfeil nach unten klicken, um die Stufe nach oben bzw. nach unten zu verschieben.



4.5.2.4 Farbe wählen

Jeder Stufe kann eine vorgegebene Standardfarbe oder eine individuelle Farbe zugewiesen werden.

1. In der Spalte **Farbe** auf das Farbfeld klicken.



→ Das Fenster **Farbe auswählen** erscheint.



2. Wählen, ob eine Standardfarbe oder eine individuelle Farbe verwendet werden soll.

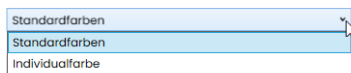

Standardfarbe

1. Auf das gewünschte Farbfeld klicken.



Folgende 8 Standardfarben stehen zur Verfügung:

- rot
- gelb
- grün
- weiß
- blau
- hellgelb
- violett
- türkis

Individualfarbe

1. Gewünschte Farbe im Farbfeld auswählen oder den entsprechenden RGB-Wert in den Feldern **Rot**, **Grün** und **Blau** eingeben.

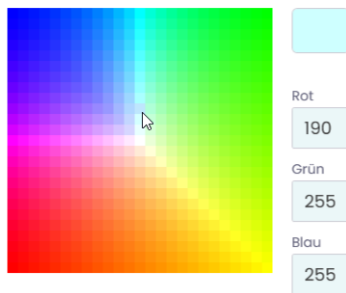

2. Auf **Farbe auswählen** klicken.

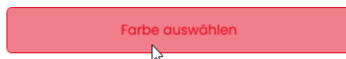

4.5.2.5 Leuchteffekt wählen

1. In der Spalte **Leuchteffekt** den gewünschten Leuchteffekt wählen.



Folgende 8 Leuchteffekte stehen zur Verfügung:

- Dauerlicht
- Blink 1Hz
- Blink 2Hz
- Blink 3Hz
- Blitz 1x
- Blitz 2x
- Blitz 3x
- Rundum
- Ohne



Die Einstellung **Ohne** kann gewählt werden, falls die Stufe nur mit Sirene belegt werden soll.

4.5.2.6 Helligkeit einstellen

1. In der Spalte **Helligkeit** aus den 4 Optionen die gewünschte Helligkeit der Stufe einstellen.

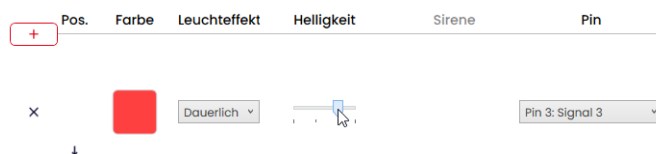

4.5.2.7 Sirene wählen

Falls die angeschlossene oder gewählte eSIGN eine Sirene hat, kann ein Signalton gewählt werden, der bei Aktivierung der Stufe ertönt.

i Falls Signaltöne für mehrere Stufen hinterlegt und die Stufen gleichzeitig angesteuert werden, ertönt die Sirene für die Farbe mit der höchsten Priorität (höchste Stelle innerhalb der Säule).

1. In der Spalte **Sirene** auf **Kein Ton** klicken.





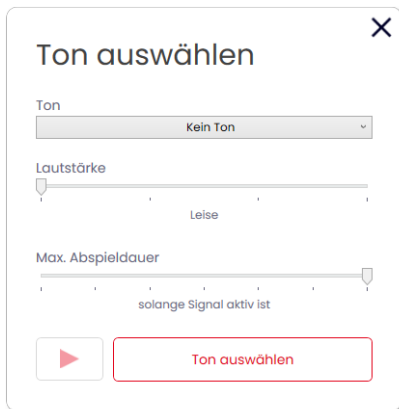



→ Das Fenster **Ton auswählen** erscheint.

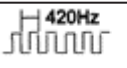
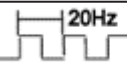
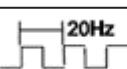
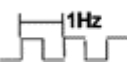

2. Den gewünschten **Ton**, die gewünschte **Lautstärke** und **Max. Abspieldauer** wählen.

Folgende 10 Tonarten stehen zur Verfügung:

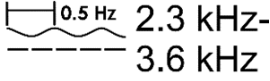
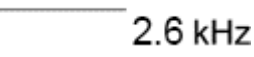
Ton	Frequenz	Beschreibung	Max. dB (A)
1	 2.7 kHz	Dauerton	104
2	 0.9 kHz	Dauerton	96
3	 2.8 kHz	Pulston	97
4	 0.9 kHz	Pulston	93
5	 2.8 kHz	Pulston	103
6	 0.9 kHz	Pulston	96
7	 2.8 kHz	Pulston	104

Ton	Frequenz	Beschreibung	Max. dB (A)
8	 0.5 Hz 2.3 kHz- 3.6 kHz	Wobbelton	104
9	 2.6 kHz	Dauerton	105
10	 1 Hz — 1200 Hz — 800 Hz	Wechselton	92

i Der gewählte Ton kann über die Schaltfläche ▶ in der Tonauswahl getestet werden. Der Ton wird dabei über den Computer abgespielt.

3. Auf **Ton auswählen** klicken.

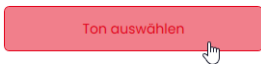

4.5.2.8 Pin wählen

 Die Felder sind mit einer Standardbelegung vorkonfiguriert, von der unteren Stufe der Säule beginnend mit Pin 1.

Bereits verwendete Pins werden grau dargestellt. Die Belegung kann bei Bedarf beliebig verändert werden.

1. In der Spalte **Pin** den Pin des 8-poligen Steckers wählen, auf dem das Signal zum Auslösen der Stufe gesendet wird.

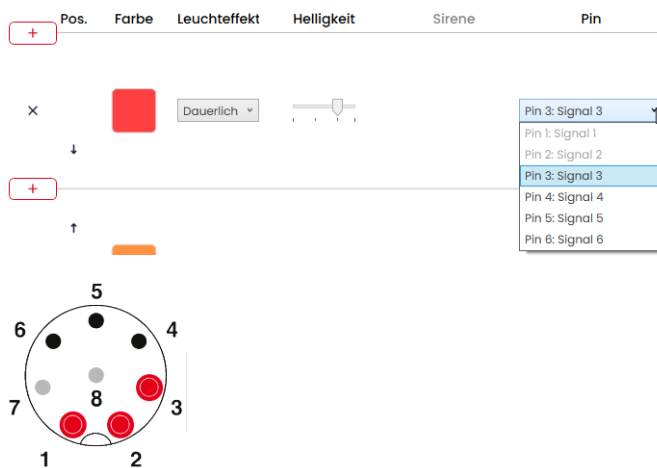

Pin-Konfiguration anpassen

Bei Bedarf kann die Zuordnung der Litzenfarbe zum Pin geändert und eine Beschreibung des Signals hinterlegt werden.

1. Unter der Pin-Übersicht auf **PIN Konfiguration** klicken.

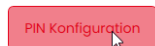

→ Das Fenster **PIN Konfiguration** erscheint.

PIN Konfiguration ✕

	Farbe	Beschreibung
Pin 1: Signal 1	WH	
Pin 2: Signal 2	BN	
Pin 3: Signal 3	GN	
Pin 4: Signal 4	YE	
Pin 5: Signal 5	GY	
Pin 6: Signal 6	PK	
Pin 7: COM	BU	
Pin 8: +24V	RD	

Speichern

2. In der Spalte **Farbe** die gewünschte Litzenfarbe eingeben.
3. In der Spalte **Beschreibung** die Beschreibung des Signals eingeben.
4. Auf **Speichern** klicken.

4.5.2.9 Ansteuerung simulieren

Nachdem alle Einstellungen vorgenommen wurden, kann die Ansteuerung simuliert werden.

1. In der Pin-Übersicht auf den Pin klicken, der die gewünschte Stufe aktivieren soll.

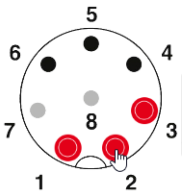

4.5.2.10 Konfiguration abschließen

1. Bei Bedarf weitere Änderungen an der Konfiguration vornehmen.
2. Sobald alle Stufen wie gewünscht konfiguriert sind, auf **Abschließen** klicken.
→ Das Fenster **Abschließen** erscheint.



3. Auf **Speichern** klicken, um die Konfiguration in einer Konfigurationsdatei zu speichern.
4. Auf **Auf Gerät übertragen** klicken, um die Konfiguration auf die angeschlossene eSIGN zu übertragen.
5. Auf **PDF-Konfigurationsblatt anzeigen** klicken, um eine Übersicht der aktuellen Konfiguration anzuzeigen.
6. Auf **PDF-Konfigurationsblatt speichern** klicken, um die Übersicht der aktuellen Konfiguration als PDF-Datei zu speichern.

4.5.3 Modus Füllstand

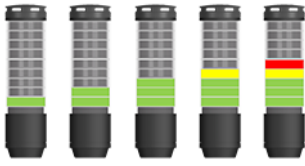

In dieser Betriebsart werden die eSIGN-Segmente als Füllstandanzeige verwendet. Dies ermöglicht eine präzise Signalisierung des Auftragsfortschritts oder der Materialverfügbarkeit in Maschinenprozessen in Form eines aufbauenden oder abfallenden Leuchtbilds.

Modus: Füllstand ✕

Gerät

eSIGN 15 Segmente mit Sirene

Farben

Einzelfarbe

Anzahl der Signalkombinationen: 15

= Anzahl zugeordneter Segmente: 15
= Anzahl nicht zugeordneter Segmente: 0

Aufteilung nicht zugeordnete Segmente

Top (Füllend)

Konfiguration erstellen

4.5.3.1 eSIGN-Variante wählen

Falls eine eSIGN angeschlossen wurde, ist die Variante entsprechend vorausgewählt. Falls keine eSIGN angeschlossen wurde, kann die Variante der zu konfigurierenden eSIGN gewählt werden.

1. Bei Bedarf im Feld **Gerät** die Variante der eSIGN wählen.

Gerät

eSIGN 15 Segmente mit Sirene

eSIGN 15 Segmente mit Sirene

eSIGN 15 Segmente

eSIGN 9 Segmente mit Sirene

eSIGN 9 Segmente

4.5.3.2 Anzahl der Signalkombinationen wählen

1. Im Bereich **Anzahl der Signalkombinationen** wählen, wie viele eSIGN-Segmente für die Füllstandanzeige verwendet werden sollen.

Falls nicht alle eSIGN-Segmente für die Füllstandanzeige verwendet werden:

2. Im Feld **Aufteilung nicht zugeordnete Segmente** wählen, wie die eSIGN-Segmente angezeigt werden, die nicht für die Füllstandanzeige verwendet werden sollen.

Einstellung	Beschreibung
Top (Füllend)	Nicht zugeordnete eSIGN-Segmente werden oben angeordnet und mit der obersten Stufe geschaltet.
Unten (Füllend)	Nicht zugeordnete eSIGN-Segmente werden unten angeordnet und mit der untersten Stufe geschaltet.
Top (Ohne Funktion)	Nicht zugeordnete eSIGN-Segmente werden oben angeordnet und sind immer aus.
Unten (Ohne Funktion)	Nicht zugeordnete eSIGN-Segmente werden unten angeordnet und sind immer aus.

4.5.3.3 Farbe wählen

Für die Anzeige des Füllstands kann eine einheitliche Farbe oder ein Farbverlauf gewählt werden. Bei einem Farbverlauf wird der Verlauf der Farbtöne zwischen den beiden Farben automatisch berechnet.

Bei Bedarf kann die Farbe jedes einzelnen Segments der Füllstandanzeige zu einem späteren Zeitpunkt angepasst werden.

1. Im Feld **Farben** wählen, ob der Füllstand in einer einheitlicher Farbe oder als Farbverlauf dargestellt werden soll.

Einzelfarbe

1. Auf das Farbfeld klicken, um die gewünschte Farbe zu wählen.
→ Das Fenster **Farbe auswählen** erscheint.



2. Wählen, ob eine Standardfarbe oder eine individuelle Farbe verwendet werden soll.

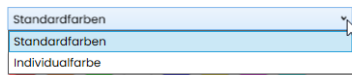

Standardfarbe

1. Auf das gewünschte Farbfeld klicken.



Folgende 8 Standardfarben stehen zur Verfügung:

- rot
- gelb
- grün
- weiß
- blau
- hellgelb
- violett
- türkis

Individualfarbe

1. Gewünschte Farbe im Farbfeld auswählen oder den entsprechenden RGB-Wert in den Feldern **Rot**, **Grün** und **Blau** eingeben.

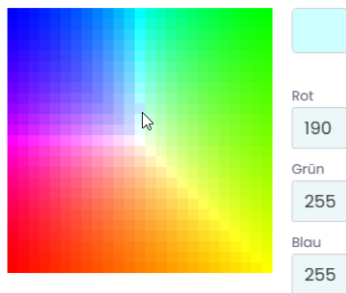

2. Auf **Farbe auswählen** klicken.



3. Auf **Konfiguration erstellen** klicken.
→ Der Bildschirm **Konfiguration** erscheint.

Farbverlauf

1. Auf die Farbfelder für die Start- und die Endfarbe des Farbverlaufs klicken.
→ Das Fenster **Farbe auswählen** erscheint.



2. Wählen, ob eine Standardfarbe oder eine individuelle Farbe verwendet werden soll.

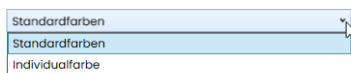

Standardfarbe

1. Auf das gewünschte Farbfeld klicken.



Individualfarbe

1. Gewünschte Farbe im Farbfeld auswählen oder den entsprechenden RGB-Wert in den Felder **Rot**, **Grün** und **Blau** eingeben.

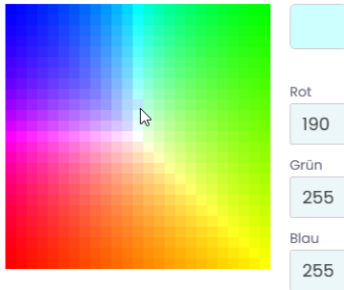

2. Auf **Farbe auswählen** klicken.



3. Auf **Konfiguration erstellen** klicken.
→ Der Bildschirm **Konfiguration** erscheint.

4.5.3.4 Füllstandanzeige konfigurieren

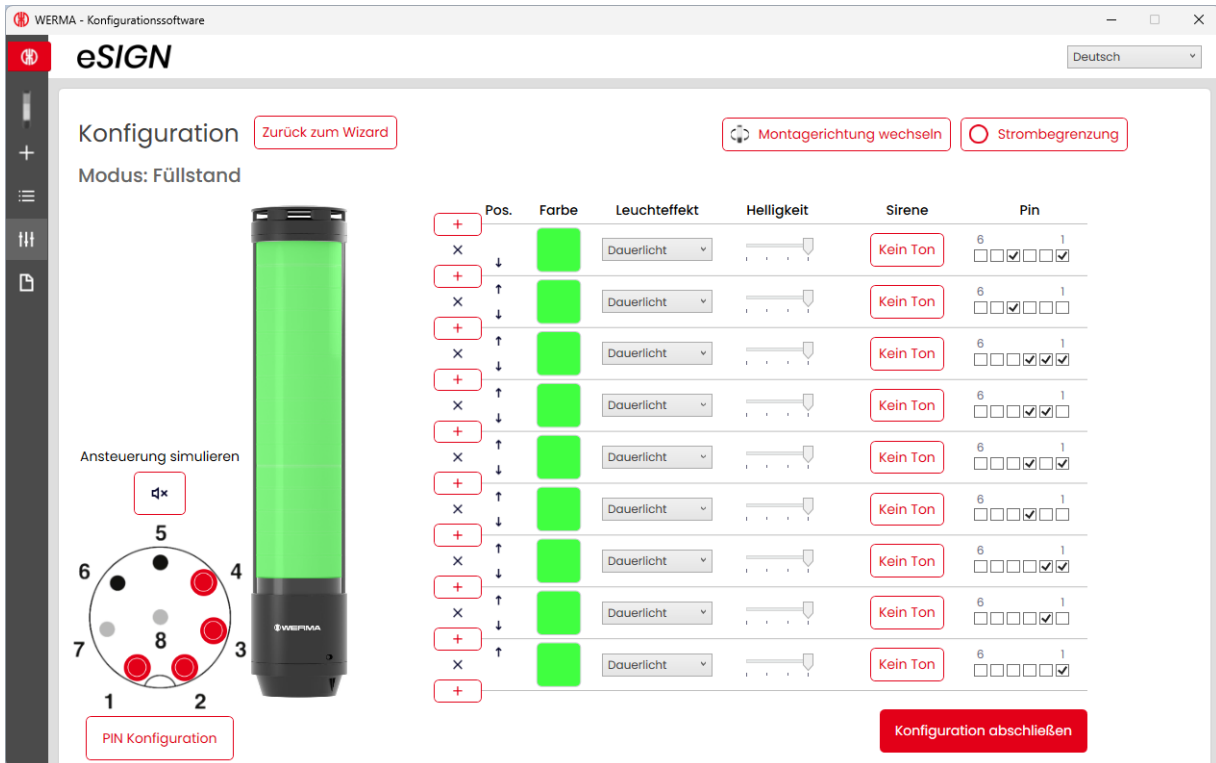

	Pos.	Farbe	Leuchteffekt	Helligkeit	Sirene	Pin
+	X ↓	■	Dauerlicht	▬	Kein Ton	6 <input type="checkbox"/> <input checked="" type="checkbox"/> 1 <input checked="" type="checkbox"/>
+	X ↓	■	Dauerlicht	▬	Kein Ton	6 <input type="checkbox"/> <input checked="" type="checkbox"/> <input type="checkbox"/> <input type="checkbox"/>
+	X ↑	■	Dauerlicht	▬	Kein Ton	6 <input type="checkbox"/> <input type="checkbox"/> <input checked="" type="checkbox"/> <input checked="" type="checkbox"/>
+	X ↓	■	Dauerlicht	▬	Kein Ton	6 <input type="checkbox"/> <input type="checkbox"/> <input checked="" type="checkbox"/> <input type="checkbox"/>
+	X ↑	■	Dauerlicht	▬	Kein Ton	6 <input type="checkbox"/> <input type="checkbox"/> <input checked="" type="checkbox"/> <input type="checkbox"/>
+	X ↓	■	Dauerlicht	▬	Kein Ton	6 <input type="checkbox"/> <input type="checkbox"/> <input checked="" type="checkbox"/> <input checked="" type="checkbox"/>
+	X ↑	■	Dauerlicht	▬	Kein Ton	6 <input type="checkbox"/> <input type="checkbox"/> <input checked="" type="checkbox"/> <input type="checkbox"/>
+	X ↓	■	Dauerlicht	▬	Kein Ton	6 <input type="checkbox"/> <input type="checkbox"/> <input type="checkbox"/> <input checked="" type="checkbox"/>
+	X ↑	■	Dauerlicht	▬	Kein Ton	6 <input type="checkbox"/> <input type="checkbox"/> <input type="checkbox"/> <input checked="" type="checkbox"/>
+	X ↓	■	Dauerlicht	▬	Kein Ton	6 <input type="checkbox"/> <input type="checkbox"/> <input type="checkbox"/> <input checked="" type="checkbox"/>

i Bei Bedarf kann die Ausrichtung der dargestellten Signalsäule über die Schaltfläche **Montagerichtung wechseln** um 180° gedreht werden.

i Bei Bedarf (z. B. um die Strombegrenzungen von Steuerungsausgängen berücksichtigen zu können) kann über die Schaltfläche **Strombegrenzung** die Leistungsaufnahme der eSIGN verringert werden. In diesem Fall wird der Strombedarf der Säule auf unter 500 mA reduziert. Als Folge wird die Helligkeit der optischen Signale bzw. die Lautstärke der akustischen Signale verringert.

i Bei Bedarf kann über den Link **Zurück zum Wizard** die Konfiguration der Farbe und Segmente erneut aufgerufen und angepasst werden.

Segmente entfernen oder hinzufügen

Segment entfernen

1. Auf **Entfernen** klicken.



→ Das Segment wurde entfernt.

Segment hinzufügen

1. Auf **Hinzufügen** klicken.

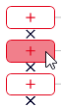

→ Das Segment wurde hinzugefügt.

Segmente verschieben

Bei Bedarf können die einzelnen Segmente nach oben oder unten verschoben werden.





1. In der Spalte **Pos.** auf den Pfeil nach oben oder auf den Pfeil nach unten klicken, um das Segment nach oben bzw. nach unten zu verschieben.

	Pos.	Farbe	Leuchteffekt	Helligkeit	Sirene	Pin	
x	↓		Dauerlich ▾		Kein Ton	6	1
x	↑		Dauerlich ▾		Kein Ton	6	1

Farbe wählen

Für jedes einzelne Segment kann bei Bedarf eine vorgegebene Standardfarbe gewählt oder eine individuelle Farbe zugewiesen werden.

1. In der Spalte **Farbe** auf das Farbfeld klicken.

Pos.	Farbe	Leuchteffekt	Helligkeit	Sirene	Pin
x		Dauerlich		Kein Ton	6 <input type="checkbox"/> <input checked="" type="checkbox"/> <input checked="" type="checkbox"/> <input checked="" type="checkbox"/>
x		Dauerlich		Kein Ton	6 <input type="checkbox"/> <input checked="" type="checkbox"/> <input checked="" type="checkbox"/> <input type="checkbox"/>

→ Das Fenster **Farbe auswählen** erscheint.



2. Wählen, ob eine Standardfarbe oder eine individuelle Farbe verwendet werden soll.

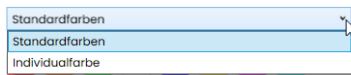

Standardfarbe

1. Auf das gewünschte Farbfeld klicken.



Folgende 8 Standardfarben stehen zur Verfügung:

- rot
- gelb
- grün
- weiß
- blau
- hellgelb
- violett
- türkis

Individualfarbe

1. Gewünschte Farbe im Farbfeld auswählen oder den entsprechenden RGB-Wert in den Feldern **Rot**, **Grün** und **Blau** eingeben.

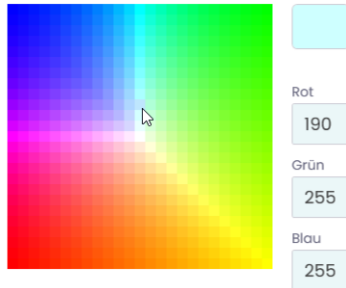

2. Auf **Farbe auswählen** klicken.



Leuchteffekt wählen

1. In der Spalte **Leuchteffekt** den gewünschten Leuchteffekt wählen.

	Pos.	Farbe	Leuchteffekt	Helligkeit	Sirene	Pin	
x	↓	■	Dauerlich	0 100	Kein Ton	6	1
	↑		Dauerlicht	0 100	Kein Ton	<input type="checkbox"/>	<input checked="" type="checkbox"/>
x	↓	■	Blink: 1Hz	0 100	Kein Ton	6	1
	↑		Blink: 2Hz	0 100	Kein Ton	<input type="checkbox"/>	<input checked="" type="checkbox"/>
x	↓	■	Blink: 3Hz	0 100	Kein Ton	6	1
	↑		Blitz: 1x	0 100	Kein Ton	<input type="checkbox"/>	<input checked="" type="checkbox"/>
x	↓	■	Blitz: 2x	0 100	Kein Ton	6	1
	↑		Blitz: 3x	0 100	Kein Ton	<input type="checkbox"/>	<input checked="" type="checkbox"/>
x	↓	■	Rundum	0 100	Kein Ton	6	1
	↑		Ohne	0 100	Kein Ton	<input type="checkbox"/>	<input checked="" type="checkbox"/>

Folgende 8 Leuchteffekte stehen zur Verfügung:

- Dauerlicht
- Blink 1Hz
- Blink 2Hz
- Blink 3Hz
- Blitz 1x
- Blitz 2x
- Blitz 3x
- Rundum
- Ohne



Die Einstellung **Ohne** kann gewählt werden, falls die Stufe nur mit Sirene belegt werden soll.

Helligkeit einstellen

1. In der Spalte **Helligkeit** aus den 4 Optionen die gewünschte Helligkeit der Stufe einstellen.

	Pos.	Farbe	Leuchteffekt	Helligkeit	Sirene	Pin	
x	↓	■	Dauerlich		Kein Ton	6	1
x	↑	■	Dauerlich		Kein Ton	6	1

Sirene wählen

Falls die angeschlossene oder gewählte eSIGN eine Sirene hat, kann ein Signalton gewählt werden, der bei Aktivierung des Segments ertönt.

i Falls Signaltöne für mehrere Stufen hinterlegt und die Stufen gleichzeitig angesteuert werden, ertönt die Sirene für die Farbe mit der höchsten Priorität (höchste Stelle innerhalb der Säule).

1. In der Spalte **Sirene** auf **Kein Ton** klicken.

	Pos.	Farbe	Leuchteffekt	Helligkeit	Sirene	Pin	
x	↓	■	Dauerlich		Kein Ton	6	1
x	↑	■	Dauerlich		Kein Ton	6	1

→ Das Fenster **Ton auswählen** erscheint.

Ton auswählen ✕

Ton: Kein Ton

Lautstärke:

Max. Abspieldauer:





solange Signal aktiv ist

▶
Ton auswählen

2. Den gewünschten **Ton**, die gewünschte **Lautstärke** und **Max. Abspieldauer** wählen.

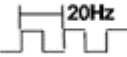
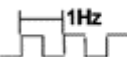
Folgende 10 Tonarten stehen zur Verfügung:

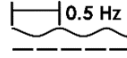
Ton	Frequenz	Beschreibung	Max. dB (A)
1	2.7 kHz	Dauerton	104
2	0.9 kHz	Dauerton	96
3	420Hz 2.8 kHz	Pulston	97
4	20Hz 0.9 kHz	Pulston	93

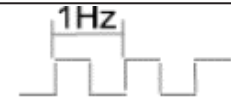
Ton	Frequenz	Beschreibung	Max. dB (A)
5	 2.8 kHz	Pulston	103
6	 0.9 kHz	Pulston	96
7	 2.8 kHz	Pulston	104
8	 2.3 kHz- 3.6 kHz	Wobbelton	104
9	 2.6 kHz	Dauerton	105
10	 1200 Hz 800 Hz	Wechselton	92

 Der gewählte Ton kann über die Schaltfläche ► in der Tonauswahl getestet werden. Der Ton wird dabei über den Computer abgespielt.

3. Auf **Ton auswählen** klicken.



Pin wählen

i Die Felder sind mit einer Standardbelegung vorkonfiguriert, von der unteren Stufe der Säule beginnend mit Pin 1.

Bereits verwendete Pins werden grau dargestellt. Die Belegung kann bei Bedarf beliebig verändert werden.

Die Ansteuerung der Füllstandanzeige erfolgt über eine Bit-Codierung. Die Kontrollkästchen in der Spalte **Pin** entsprechen den 6 Pins bzw. Signalleitungen. Das Setzen eines Hakens in einem oder mehreren Kontrollkästchen zeigt an, dass diese Pins bzw. Signalleitungen angesteuert werden müssen, um die entsprechende Einstellung zu aktivieren.

Beispiel:

Für die Darstellung der kompletten Säule in grün müssen die Pins 1-4 angesteuert werden.

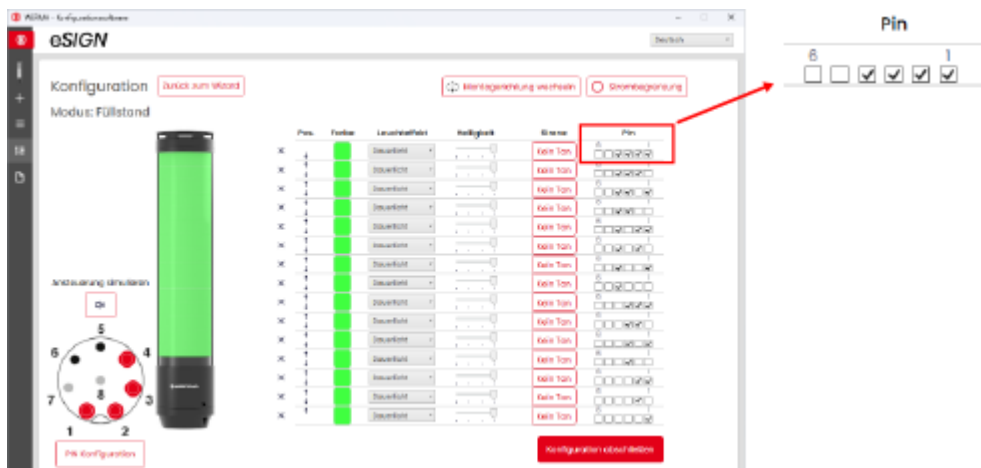

1. In der Spalte **Pin** die Pins des 8-poligen Steckers wählen, auf dem das Signal zum Auslösen der Stufe gesendet wird.

Pos.	Farbe	Leuchteffekt	Helligkeit	Sirene	Pin
X	Grün	Dauerlich	...	Kein Ton	<input type="checkbox"/> 6 <input checked="" type="checkbox"/> 5 <input checked="" type="checkbox"/> 4 <input checked="" type="checkbox"/> 3 <input checked="" type="checkbox"/> 2 <input type="checkbox"/> 1
X	Grün	Dauerlich	...	Kein Ton	<input type="checkbox"/> 6 <input checked="" type="checkbox"/> 5 <input checked="" type="checkbox"/> 4 <input checked="" type="checkbox"/> 3 <input checked="" type="checkbox"/> 2 <input type="checkbox"/> 1

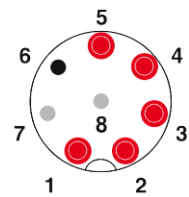

Pin-Konfiguration anpassen

Bei Bedarf kann die Zuordnung der Litzenfarbe zum Pin geändert und eine Beschreibung des Signals hinterlegt werden.

1. Unter der Pin-Übersicht auf **PIN Konfiguration** klicken.

PIN Konfiguration

→ Das Fenster **PIN Konfiguration** erscheint.

	Farbe	Beschreibung
Pin 1: Signal 1	WH	
Pin 2: Signal 2	BN	
Pin 3: Signal 3	GN	
Pin 4: Signal 4	YE	
Pin 5: Signal 5	GY	
Pin 6: Signal 6	PK	
Pin 7: COM	BU	
Pin 8: +24V	RD	

Speichern

2. In der Spalte **Farbe** die gewünschte Litzenfarbe eingeben.
3. In der Spalte **Beschreibung** die Beschreibung des Signals eingeben.
4. Auf **Speichern** klicken.

4.5.3.5 Ansteuerung simulieren

Nachdem alle Einstellungen vorgenommen wurden, kann die Ansteuerung simuliert werden.

1. In der Pin-Übersicht auf den Pin klicken, der die gewünschte Stufe aktivieren soll.

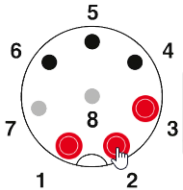

4.5.3.6 Konfiguration abschließen

1. Bei Bedarf weitere Änderungen an der Konfiguration vornehmen.
2. Sobald alle Stufen wie gewünscht konfiguriert sind, auf **Abschließen** klicken.
→ Das Fenster **Abschließen** erscheint.



3. Auf **Speichern** klicken, um die Konfiguration in einer Konfigurationsdatei zu speichern.
4. Auf **Auf Gerät übertragen** klicken, um die Konfiguration auf die angeschlossene eSIGN zu übertragen.
5. Auf **PDF-Konfigurationsblatt anzeigen** klicken, um eine Übersicht der aktuellen Konfiguration anzuzeigen.
6. Auf **PDF-Konfigurationsblatt speichern** klicken, um die Übersicht der aktuellen Konfiguration als PDF-Datei zu speichern.

4.5.4 Modus Individual



In dieser Betriebsart wird eine beliebige Kombination aus individuellen Segmenteinstellungen als eigenes Schaltsignal abgebildet. Jedes eSIGN-Segment kann individuell eingestellt und die Gesamteinstellung für die komplette Säule als ein Signalbild angesteuert werden. Der Modus **Individual** ermöglicht auf diese Art und Weise ein Maximum an individuellen Signalisierungsmöglichkeiten.

4.5.4.1 eSIGN-Variante wählen

Falls eine eSIGN angeschlossen wurde, ist die Variante entsprechend vorausgewählt. Falls keine eSIGN angeschlossen wurde, kann die Variante der zu konfigurierenden eSIGN gewählt werden.

1. Bei Bedarf im Feld **Gerät** die Variante der eSIGN wählen.

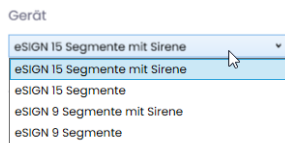

2. Auf **Konfiguration erstellen** klicken.
→ Der Bildschirm **Konfiguration** erscheint.

4.5.4.2 Signalbilder konfigurieren

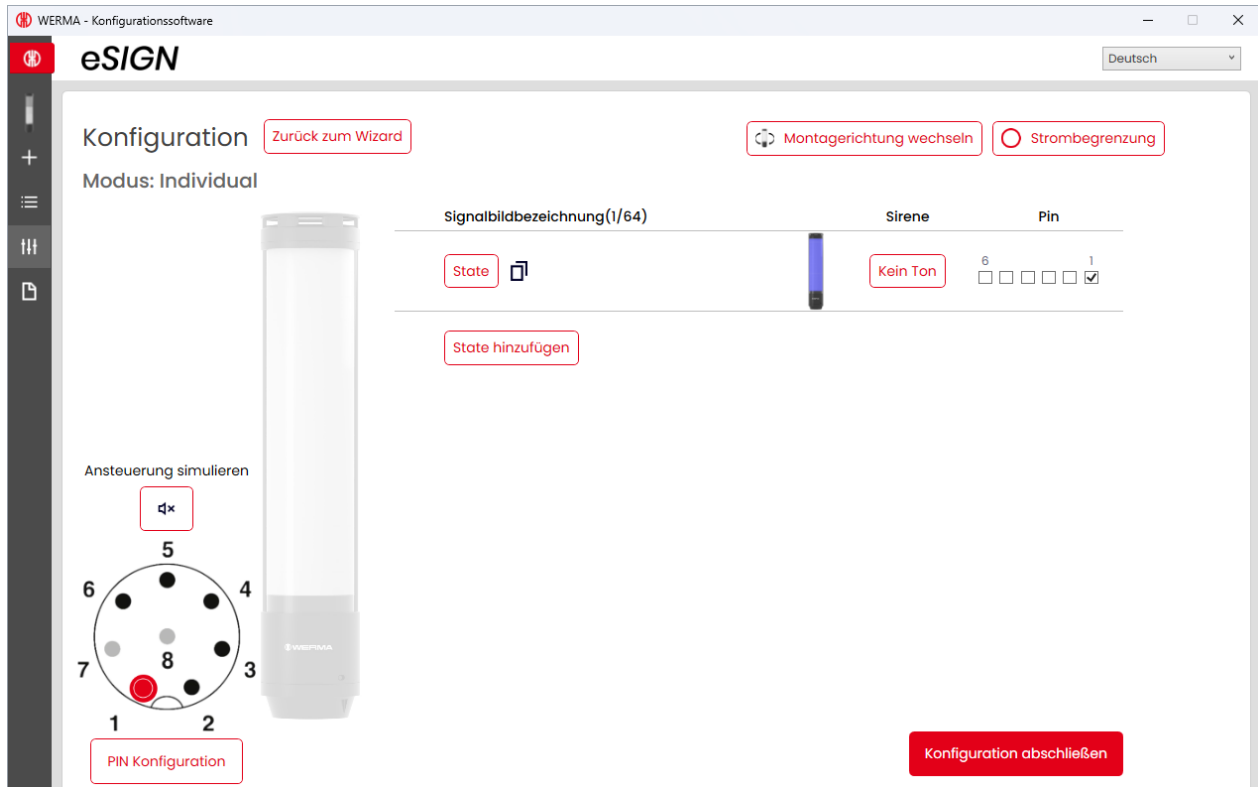

i Bei Bedarf kann die Ausrichtung der dargestellten Signalsäule über die Schaltfläche **Montagerichtung wechseln** um 180° gedreht werden.

i Bei Bedarf (z. B. um die Strombegrenzungen von Steuerungsausgängen berücksichtigen zu können) kann über die Schaltfläche **Strombegrenzung** die Leistungsaufnahme der eSIGN verringert werden. In diesem Fall wird der Strombedarf der Säule auf unter 500 mA reduziert. Als Folge wird die Helligkeit der optischen Signale bzw. die Lautstärke der akustischen Signale verringert.

i Bei Bedarf kann über den Link **Zurück zum Wizard** die Konfiguration der eSIGN-Variante erneut aufgerufen und angepasst werden.

Signalbild anpassen



Es können bis zu 64 Signalbilder konfiguriert und auf eine eSIGN übertragen werden.

Ein Signalbild besteht aus den einzelnen optischen Einstellungen jedes Segments und ggf. einem Signalton.

1. Auf **State** klicken.

Signalbildbezeichnung(1/64)



→ Das Fenster **Signalbild** erscheint.

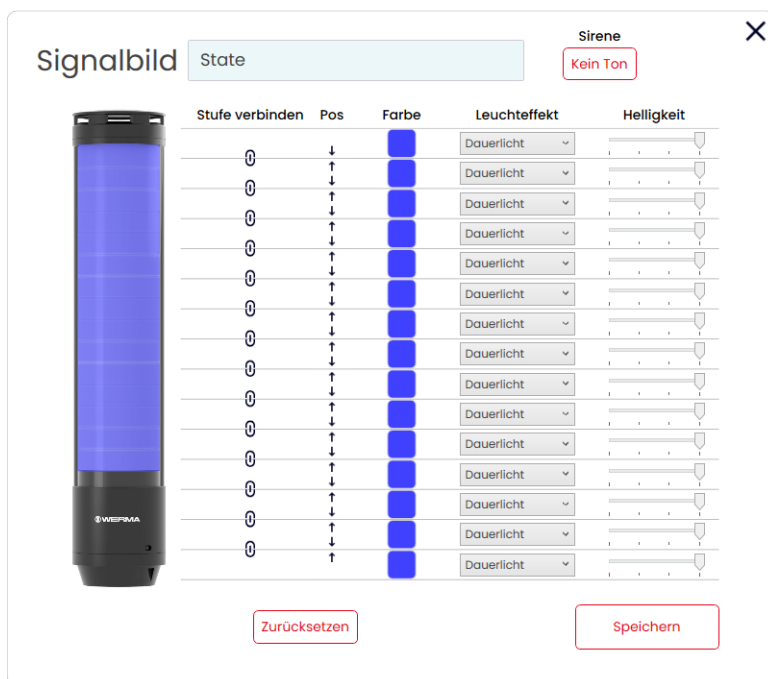

Bei Bedarf kann das aktuelle Signalbild über die Schaltfläche **Zurücksetzen** auf die Standardeinstellungen zurückgesetzt werden.

Signalbild benennen

1. Im Feld **Signalbild** eine Bezeichnung für das aktuelle Signalbild eingeben.

Sirene wählen

Falls die angeschlossene oder gewählte eSIGN eine Sirene hat, kann ein Signalton gewählt werden, der bei Aktivierung des Signalbilds ertönt.

1. Im Feld **Sirene** auf **Kein Ton** klicken.



→ Das Fenster **Ton auswählen** erscheint.

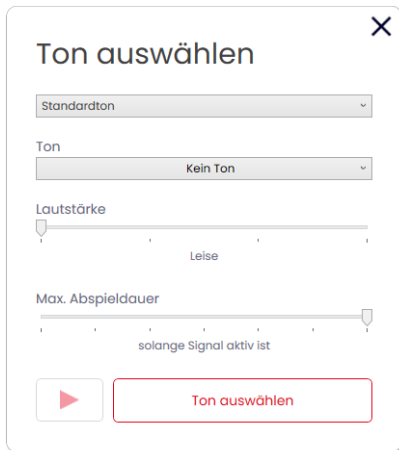



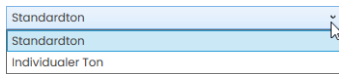



2. Wählen, ob ein Standardton oder ein individueller Ton verwendet werden soll.

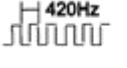
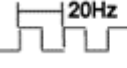
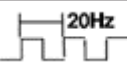
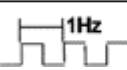

Standardton

3. Den gewünschten **Ton**, die gewünschte **Lautstärke** und **Max. Abspieldauer** wählen.

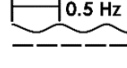
Folgende 10 Tonarten stehen zur Verfügung:

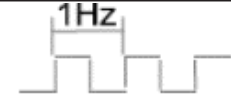
Ton	Frequenz	Beschreibung	Max. dB (A)
1	 2.7 kHz	Dauerton	104
2	 0.9 kHz	Dauerton	96
3	 2.8 kHz	Pulston	97
4	 0.9 kHz	Pulston	93
5	 2.8 kHz	Pulston	103
6	 0.9 kHz	Pulston	96
7	 2.8 kHz	Pulston	104
8	 2.3 kHz- 3.6 kHz	Wobbelton	104
9	 2.6 kHz	Dauerton	105
10	 1200 Hz 800 Hz	Wechselton	92

i Der gewählte Ton kann über die Schaltfläche ► in der Tonauswahl getestet werden. Der Ton wird dabei über den Computer abgespielt.

4. Auf **Ton auswählen** klicken.

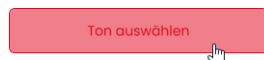

Individualer Ton

Ton auswählen
✕

Individualer Ton

Grafische Parameterbeschreibung

Lautstärke

Leise

Tonart

Dauerton

Haltedauer Frequenz 2(ms) ?

0

Frequenz 1 (Hz) ?

1000

Folge/Anzahl ?

0

Pause bis Wiederholung (ms) ?

0

Pause zwischen Zyklen (ms) ?

0

Ton auswählen

1. Einstellungen wie gewünscht vornehmen.



Die Option **Individualer Ton** bietet die Möglichkeit, aus verschiedenen Parametern, einen kundenindividuellen Ton zu generieren.

Weiterführende Informationen zu den einzelnen Einstellungen können über die Schaltfläche **Grafische Parameterbeschreibung** und durch einen Klick auf **?** aufgerufen werden.

Über die Schaltfläche **Grafische Parameterbeschreibung** kann folgendes Bild abgerufen werden, um die Auswirkung der einzelnen Einstellungen zu verdeutlichen:

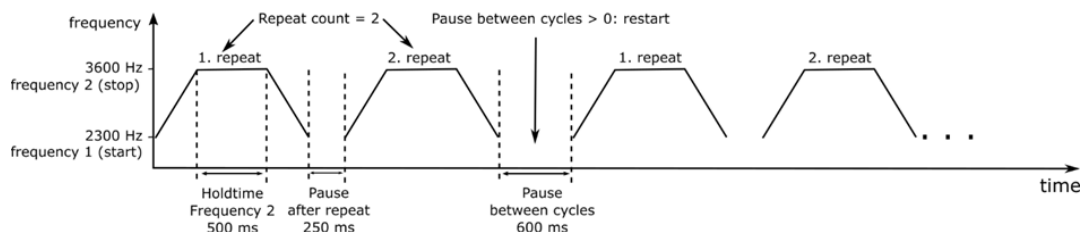

2. Auf **Ton auswählen** klicken.

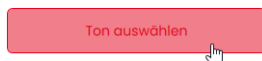

Segmente verbinden oder trennen

Bei Bedarf können mehrere Segmente zu einer Stufe verbunden und wieder getrennt werden.

Segmente verbinden

1. In der Spalte **Stufen verbinden** auf das Symbol **Stufen verbinden** klicken.



Segmente trennen

1. In der Spalte **Stufen verbinden** auf das Symbol **Stufen trennen** klicken.



Stufen verschieben

Bei Bedarf können die einzelnen Stufen nach oben oder unten verschoben werden.

1. In der Spalte **Pos.** auf den Pfeil nach oben oder auf den Pfeil nach unten klicken, um die Stufe nach oben bzw. nach unten zu verschieben.

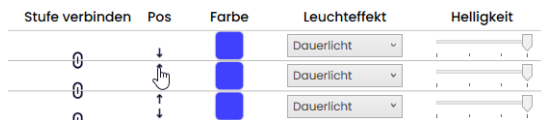

Farbe wählen

Für jedes einzelne Segment kann bei Bedarf eine vorgegebene Standardfarbe gewählt oder eine individuelle Farbe zugewiesen werden.

1. In der Spalte **Farbe** auf das Farbfeld klicken.



→ Das Fenster **Farbe auswählen** erscheint.



2. Wählen, ob eine Standardfarbe oder eine individuelle Farbe verwendet werden soll.

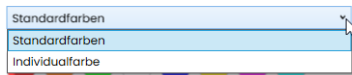

Standardfarbe

1. Auf das gewünschte Farbfeld klicken.



Folgende 8 Standardfarben stehen zur Verfügung:

- rot
- gelb
- grün
- weiß
- blau
- hellgelb
- violett
- türkis

Individualfarbe

1. Gewünschte Farbe im Farbfeld auswählen oder den entsprechenden RGB-Wert in den Feldern **Rot**, **Grün** und **Blau** eingeben.

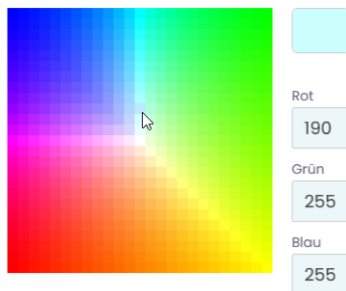

2. Auf **Farbe auswählen** klicken.

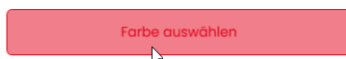

Leuchteffekt wählen

1. In der Spalte **Leuchteffekt** den gewünschten Leuchteffekt wählen.

Stufe verbinden	Pos	Farbe	Leuchteffekt	Helligkeit
0	↓	■	Dauerlicht	▬
0	↑	■	Dauerlicht	▬
0	↓	■	Blink: 1Hz	▬
0	↑	■	Blink: 2Hz	▬
0	↓	■	Blink: 3Hz	▬
0	↑	■	Blitz: 1x	▬
0	↓	■	Blitz: 2x	▬
0	↑	■	Blitz: 3x	▬
0	↓	■	Rundum	▬
0	↑	■	Ohne	▬
0	↓	■	Dauerlicht	▬

Folgende 8 Leuchteffekte stehen zur Verfügung:

- Dauerlicht
- Blink 1Hz
- Blink 2Hz
- Blink 3Hz
- Blitz 1x
- Blitz 2x
- Blitz 3x
- Rundum
- Ohne

Helligkeit einstellen

1. In der Spalte **Helligkeit** aus den 4 Optionen die gewünschte Helligkeit der Stufe einstellen.

Stufe verbinden	Pos	Farbe	Leuchteffekt	Helligkeit
0	↓	■	Dauerlicht	▬
0	↑	■	Dauerlicht	▬

Sobald alle Einstellungen vorgenommen wurden:

2. Auf **Speichern** klicken.

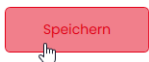

4.5.4.3 Pin wählen

- i** Die Felder sind mit einer Standardbelegung vorkonfiguriert.
Die Belegung kann bei Bedarf beliebig verändert werden.

Die Ansteuerung der einzelnen Signalbilder erfolgt über eine Bit-Codierung. Die Kontrollkästchen in der Spalte **Pin** entsprechen den 6 Pins bzw. Signalleitungen. Das Setzen eines Hakens in einem oder mehreren Kontrollkästchen zeigt an, dass diese Pins bzw. Signalleitungen angesteuert werden müssen, um das entsprechende Signalbild zu aktivieren.

Beispiel:

Für die Aktivierung des zweiten Signalbilds müssen die Pins 1-4 angesteuert werden.

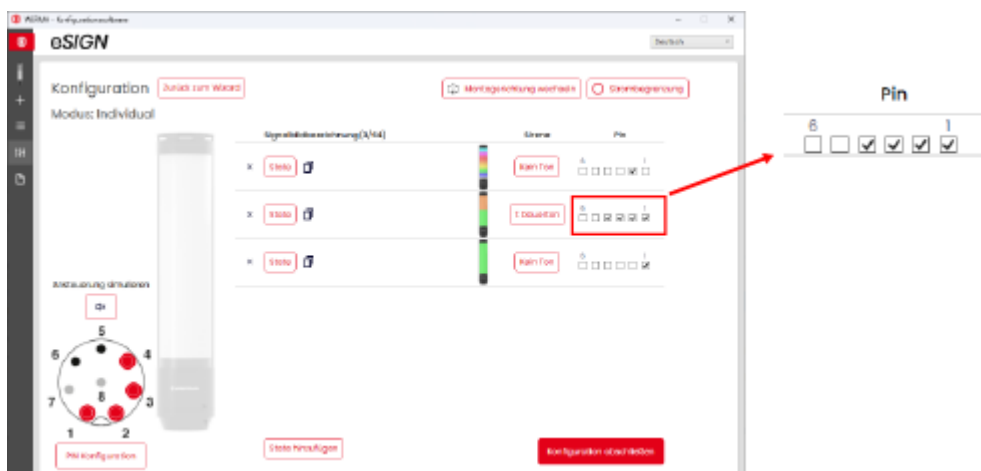

- In der Spalte **Pin** die Pins des 8-poligen Steckers wählen, auf dem das Signal zum Auslösen des Signalbilds gesendet wird.

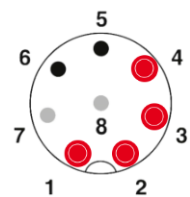
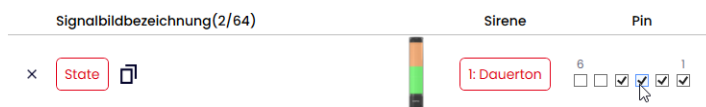

Pin-Konfiguration anpassen

Bei Bedarf kann die Zuordnung der Litzenfarbe zum Pin geändert und eine Beschreibung des Signals hinterlegt werden.

1. Unter der Pin-Übersicht auf **PIN Konfiguration** klicken.

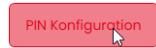

→ Das Fenster **PIN Konfiguration** erscheint.

PIN Konfiguration ✕

	Farbe	Beschreibung
Pin 1: Signal 1	WH	
Pin 2: Signal 2	BN	
Pin 3: Signal 3	GN	
Pin 4: Signal 4	YE	
Pin 5: Signal 5	GY	
Pin 6: Signal 6	PK	
Pin 7: COM	BU	
Pin 8: +24V	RD	

Speichern

2. In der Spalte **Farbe** die gewünschte Litzenfarbe eingeben.
3. In der Spalte **Beschreibung** die Beschreibung des Signals eingeben.
4. Auf **Speichern** klicken.

4.5.4.4 Signalbild duplizieren



Es können bis zu 64 Signalbilder konfiguriert und auf eine eSIGN übertragen werden.

Ein Signalbild besteht aus den einzelnen optischen Einstellungen jedes Segments und ggf. einem Signalton.

1. In der Zeile des gewünschten Signalbilds auf **Duplizieren** klicken.



2. Das Signalbild wie beschrieben konfigurieren.

4.5.4.5 Signalbild hinzufügen



Es können bis zu 64 Signalbilder konfiguriert und auf eine eSIGN übertragen werden.

Ein Signalbild besteht aus den einzelnen optischen Einstellungen jedes Segments und ggf. einem Signalton.

1. Auf **State hinzufügen** klicken.

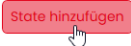

2. Signalbild wie beschrieben konfigurieren.

4.5.4.6 Signalbild löschen

1. In der Zeile des gewünschten Signalbilds auf **Entfernen** klicken.



4.5.4.7 Ansteuerung simulieren

Nachdem alle Einstellungen vorgenommen wurden, kann die Ansteuerung simuliert werden.

1. In der Pin-Übersicht auf den Pin klicken, der das gewünschte Signalbild aktivieren soll.

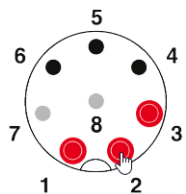

4.5.4.8 Konfiguration abschließen

1. Bei Bedarf weitere Änderungen an der Konfiguration vornehmen.
2. Sobald alle Signalbilder wie gewünscht konfiguriert sind, auf **Abschließen** klicken.
→ Das Fenster **Abschließen** erscheint.

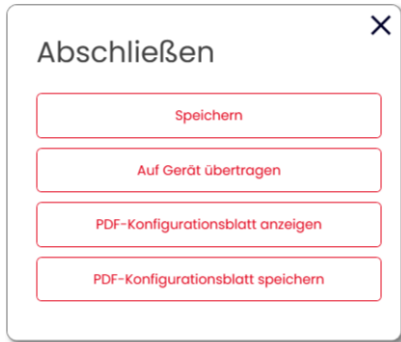

3. Auf **Speichern** klicken, um die Konfiguration in einer Konfigurationsdatei zu speichern.
4. Auf **Auf Gerät übertragen** klicken, um die Konfiguration auf die angeschlossene eSIGN zu übertragen.
5. Auf **PDF-Konfigurationsblatt anzeigen** klicken, um eine Übersicht der aktuellen Konfiguration anzuzeigen.
6. Auf **PDF-Konfigurationsblatt speichern** klicken, um die Übersicht der aktuellen Konfiguration als PDF-Datei zu speichern.

4.6 Konfiguration aus Beispielvorlagen übernehmen

Die WERMA - Konfigurationssoftware stellt verschiedene vordefinierte Konfigurationen bereit, die direkt auf eine angeschlossene eSIGN übertragen oder als Grundlage für eigene Konfigurationen verwendet werden können.

1. Im Bereich **Konfiguration** auf **Aus Beispielvorlagen übernehmen** klicken.

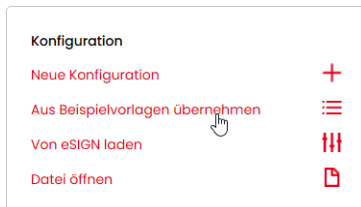

→ Das Fenster **Konfiguration aus Beispielvorlagen übernehmen** erscheint.

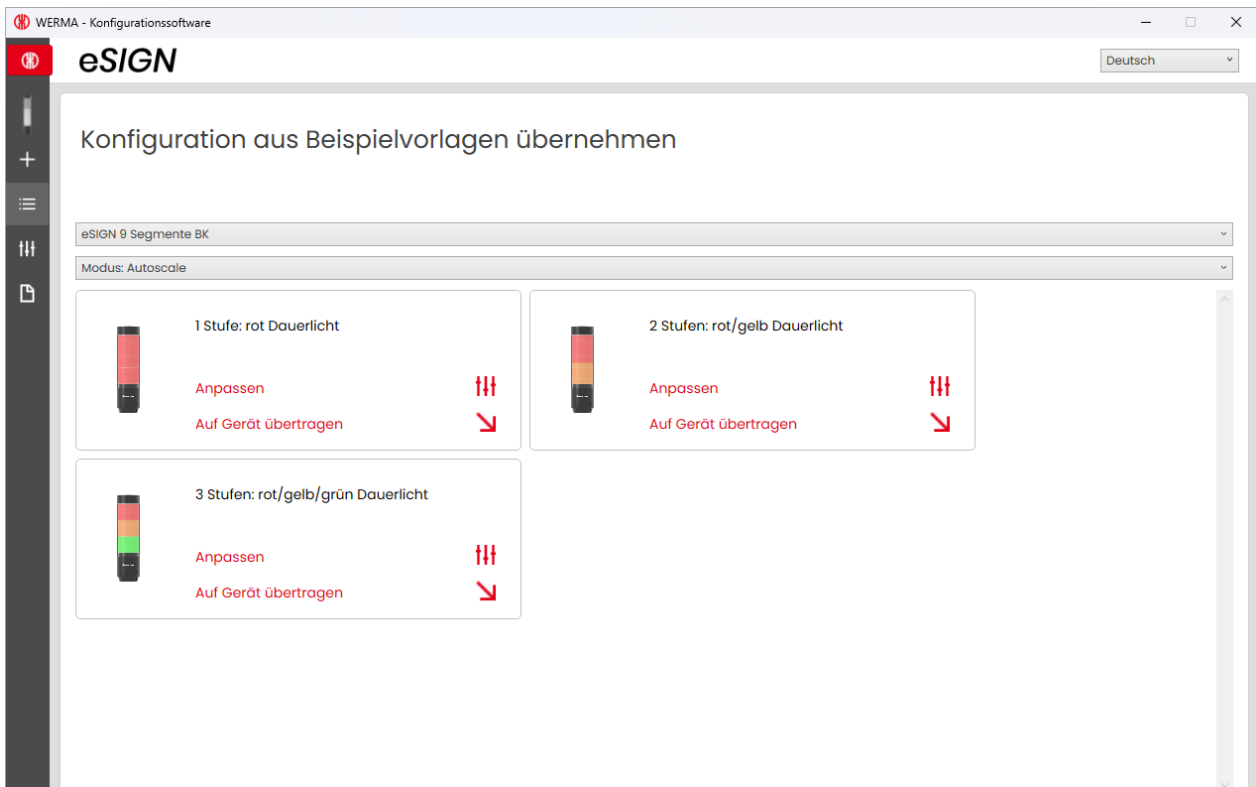

2. Variante der eSIGN wählen.
3. Modus wählen.
→ Die verfügbaren Vorlagen werden angezeigt.
4. In der gewünschten Vorlage auf **Anpassen** klicken, um die Vorlage zu laden und weiter zu bearbeiten.
5. Auf **Auf Gerät übertragen** klicken, um die Vorlage zu laden und direkt auf die angeschlossene eSIGN zu übertragen.



Für weitere Informationen zur Konfiguration, siehe "Neue Konfiguration erstellen", S. 16.

4.7 Konfiguration von der angeschlossenen eSIGN laden

Falls eine eSIGN am Computer angeschlossen ist, bietet die WERMA - Konfigurationssoftware die Möglichkeit, die aktuelle Konfiguration (ggf. Auslieferungszustand) zur Bearbeitung zu öffnen. Falls keine eSIGN angeschlossen ist, ist dieser Menüpunkt verblasst.

1. Im Bereich **Konfiguration** auf **Von eSIGN laden** klicken.

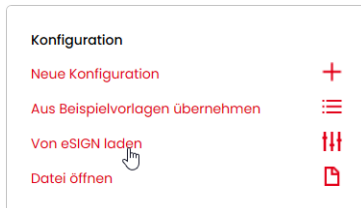

→ Das Fenster **Konfiguration** erscheint im eingestellten Modus und ist bereits mit der aktuellen Konfiguration befüllt.

 Für weitere Informationen zur Konfiguration, siehe "Neue Konfiguration erstellen", S. 16.

4.8 Bestehende Konfiguration öffnen

1. Im Bereich **Konfiguration** auf **Datei öffnen** klicken.

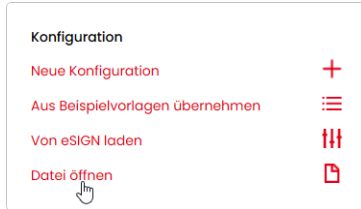

2. Gewünschte Konfigurationsdatei wählen und auf **Öffnen** klicken.



Alternativ können über das Seitenmenü die zuletzt verwendeten Konfigurationen angezeigt werden (siehe "*Überblick*", S. 14).

4.9 Firmware aktualisieren



Um eine Firmware-Aktualisierung durchführen zu können, muss der Computer mit dem Internet verbunden und eine eSIGN angeschlossen sein.

1. Im Bereich **Firmware** auf **Auf neue Firmware prüfen** klicken.

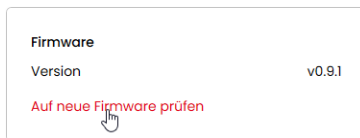

- Die WERMA - Konfigurationssoftware sucht nach Firmware-Aktualisierungen für die angeschlossene eSIGN.
- Falls eine Aktualisierung gefunden wurde, erscheint eine entsprechende Meldung.

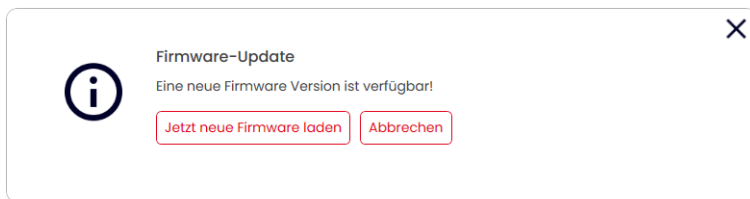

2. Auf **Jetzt neue Firmware laden** klicken.

- Die neue Firmware wird auf die angeschlossene eSIGN übertragen.

5 MC55 Touch S konfigurieren

5.1 Funktion

Mit dem neuen MC55 Touch S wird aus einer mehrfarbigen Statusleuchte eine interaktive Schnittstelle für Bediener. Mit der intuitiven Konfigurationssoftware lassen sich einfach mehrere Signalisierungsmodi mit verschiedenen Farben, Leuchtbildern und Tönen sowie zeitgesteuerte Eskalationen realisieren.

Von einer einfachen Quittierung eines akustischen Alarms, über das Durchschalten eines 24-V-Signals, bis zur Abbildung von Prozessabläufen mithilfe zeitgesteuerter Eskalationen bietet der MC55 Touch S unterschiedlichste Einsatzmöglichkeiten.

5.2 Hardware-Beschreibung

Die Informationen zur Hardware gelten für folgende Artikelnummern:

- 240.160.55 MC55 Touch S 24VDC
- 240.170.55 MC55 Touch S 24VDC Akustik
- 240.260.55 MC55 Touch 24VDC NPN
- 240.270.55 MC55 Touch 24VDC NPN Akustik
- 240.280.55 MC55 Touch 24VDC PNP
- 240.290.55 MC55 Touch 24VDC PNP Akustik

5.2.1 Übersicht Anschlussbereich

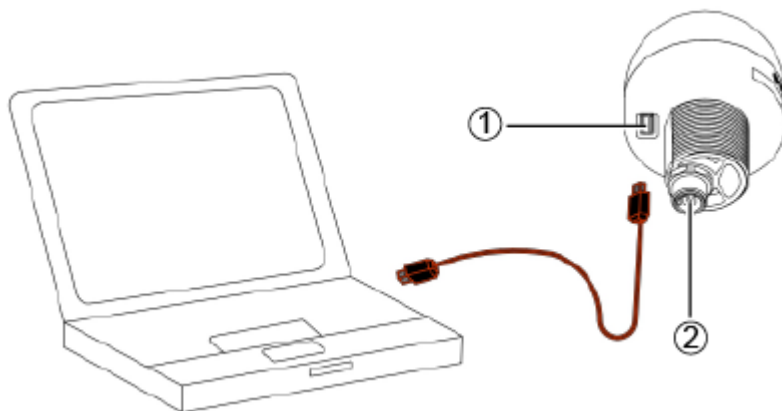

Pos.	Beschreibung
1	USB-C-Anschluss
2	M12-Stecker 5-polig

5.2.2 Übersicht M12-Stecker 5-polig

Der Anschluss des MC55 Touch S erfolgt über einen 5-poligen M12-Stecker mit folgender Belegung:

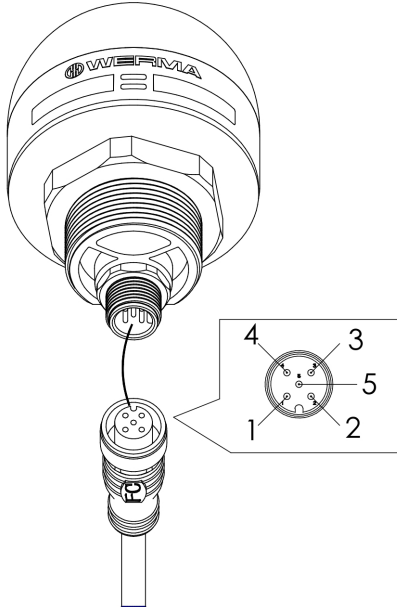

M12 Pinbelegung	Litzenfarbe M12-Kabel	Funktion
1	braun	Signal 1
2	weiß	Signal 2
3	blau	COM
4	schwarz	Ausgang 24 V; 200 mA
5	grau	Signal 3

5.2.3 Standardeinstellung

Der MC55 Touch S wird standardmäßig im Modus Schalter ausgeliefert. Bei Aktivierung des Touch Inputs werden 24 V am Ausgang geschaltet.

5.3 Überblick

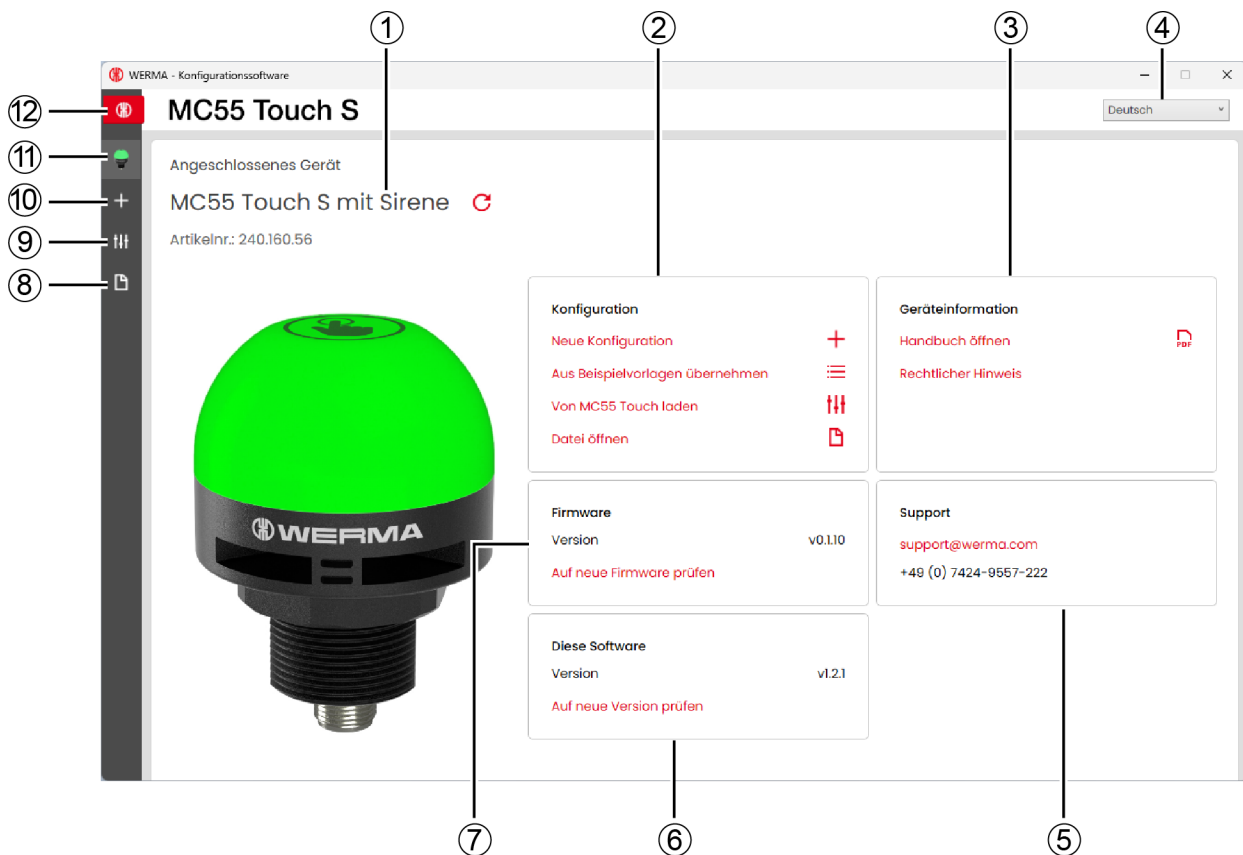

Pos.	Beschreibung
1	Variante des angeschlossenen MC55 Touch S
2	Bereich Konfiguration
3	Bereich Geräteinformation
4	Sprache einstellen
5	Bereich Support
6	Bereich Diese Software
7	Bereich Firmware
8	Bestehende Konfiguration öffnen
9	Konfiguration vom MC55 Touch S laden
10	Konfiguration aus Beispielvorlagen übernehmen
11	Startbildschirm aufrufen
12	Geräteauswahl

5.3.1 Bereich Konfiguration

Im Bereich **Konfiguration** gibt es folgende Möglichkeiten, eine Konfiguration vorzunehmen:

- **Neue Konfiguration:** Eine neue Konfiguration erstellen (siehe "Neue Konfiguration erstellen", S. 74).
- **Aus Beispielvorlagen übernehmen:** Standard-Vorlagen öffnen, die sofort auf das Gerät überspielt werden können (siehe "Konfiguration aus Beispielvorlagen übernehmen", S. 87).
- **Von MC55 Touch laden:** Aktuelle Konfiguration (ggf. Auslieferungszustand) zur Bearbeitung öffnen (siehe "Konfiguration vom angeschlossenen MC55 Touch S laden", S. 89).
- **Datei öffnen:** Eine bestehende Konfiguration öffnen und wiederverwenden (siehe "Bestehende Konfiguration öffnen", S. 90).

5.3.2 Bereich Geräteinformation

Im Bereich **Geräteinformation** können das Handbuch und rechtliche Hinweise aufgerufen werden.

5.3.3 Bereich Support

Im Bereich **Support** werden die Kontaktinformationen des WERMA-Supports angezeigt.

5.3.4 Bereich Diese Software

Im Bereich **Diese Software** wird der Versionsstand der WERMA - Konfigurationssoftware angezeigt und eine Möglichkeit zur Aktualisierung der Konfigurationssoftware angeboten.

5.3.5 Bereich Firmware

Im Bereich **Firmware** werden Informationen zur Firmware des angeschlossenen MC55 Touch S angezeigt und eine Möglichkeit zur Aktualisierung der Firmware angeboten.

5.4 Sprache einstellen

1. Im Auswahlménü die gewünschte Sprache wählen.

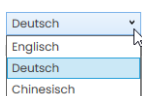

5.5 Neue Konfiguration erstellen

i Die Konfiguration kann mit oder ohne angeschlossenen MC55 Touch S durchgeführt werden.

i Der MC55 Touch S kann gleichzeitig per USB-Kabel mit einem Computer und mit der 24-V-Stromversorgung über das M12-Kabel verbunden werden.

1. MC55 Touch S per USB-Kabel an Computer anschließen.
→ Die WERMA - Konfigurationssoftware erkennt den angeschlossenen MC55 Touch S.

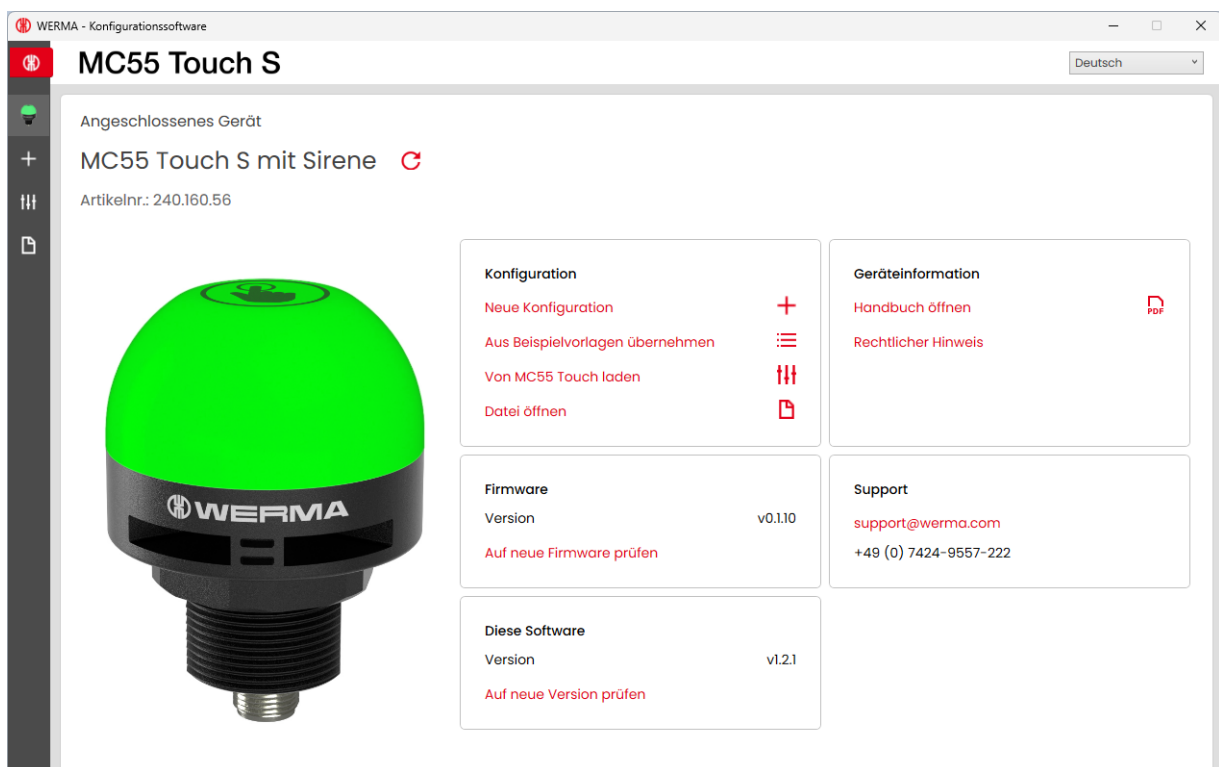

2. Falls die WERMA - Konfigurationssoftware den angeschlossenen MC55 Touch S nicht erkennt: Auf **Angeschlossenenes Gerät aktualisieren** klicken.

kein Gerät verbunden 

3. Im Bereich **Konfiguration** auf **Neue Konfiguration** klicken.

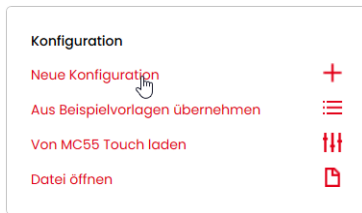

→ Der Bildschirm **Konfiguration** erscheint.

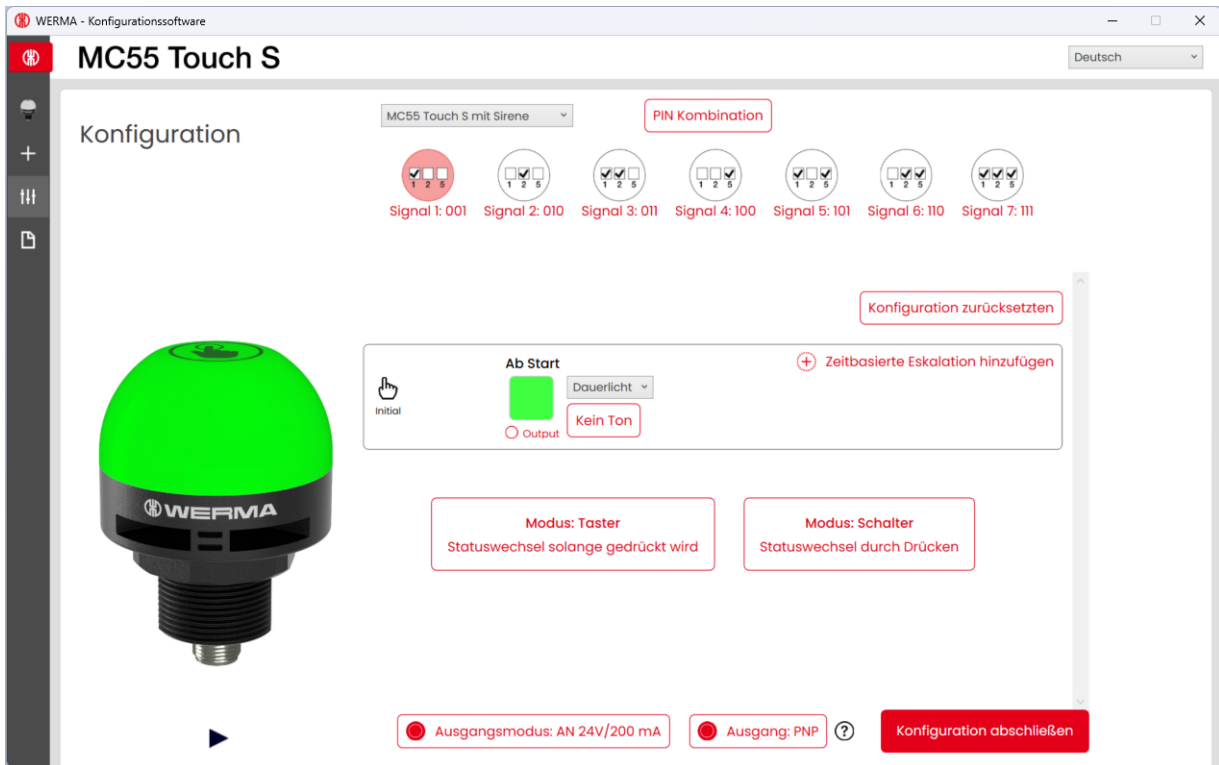

4. Bei Bedarf die Variante des zu konfigurierenden MC55 Touch S wählen.

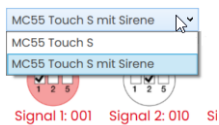

5. **Modus: Schalter** oder **Modus: Taster** wählen.

5.5.1 Signaleingang wählen

Jeder Signaleingang kann separat konfiguriert werden. Die Icons zeigen die entsprechende PIN-Belegung.

1. Auf gewünschten Signaleingang klicken.



5.5.1.1 Signaleingang umbenennen

Bei Bedarf können die Signaleingänge umbenannt und mit einer Beschreibung ergänzt werden.

1. Über der Übersicht der Eingangssignale auf **PIN Kombination** klicken.

PIN Kombination

→ Das Fenster **PIN Kombination** erscheint.

PIN Kombination

✕

	Kurzname	Beschreibung
Signal 1: 001	<input type="text" value="Signal 1"/>	<input type="text"/>
Signal 2: 010	<input type="text" value="Signal 2"/>	<input type="text"/>
Signal 3: 011	<input type="text" value="Signal 3"/>	<input type="text"/>
Signal 4: 100	<input type="text" value="Signal 4"/>	<input type="text"/>
Signal 5: 101	<input type="text" value="Signal 5"/>	<input type="text"/>
Signal 6: 110	<input type="text" value="Signal 6"/>	<input type="text"/>
Signal 7: 111	<input type="text" value="Signal 7"/>	<input type="text"/>

2. In der Spalte **Kurzname** die gewünschte Bezeichnung eingeben.
3. In der Spalte **Beschreibung** die Beschreibung des Signals eingeben.
4. Auf **Speichern** klicken.

5.5.2 Modus ändern

Für jeden Signaleingang kann nachträglich zwischen dem Modus **Taster** und Modus **Schalter** gewählt werden.

5.5.2.1 Modus Taster

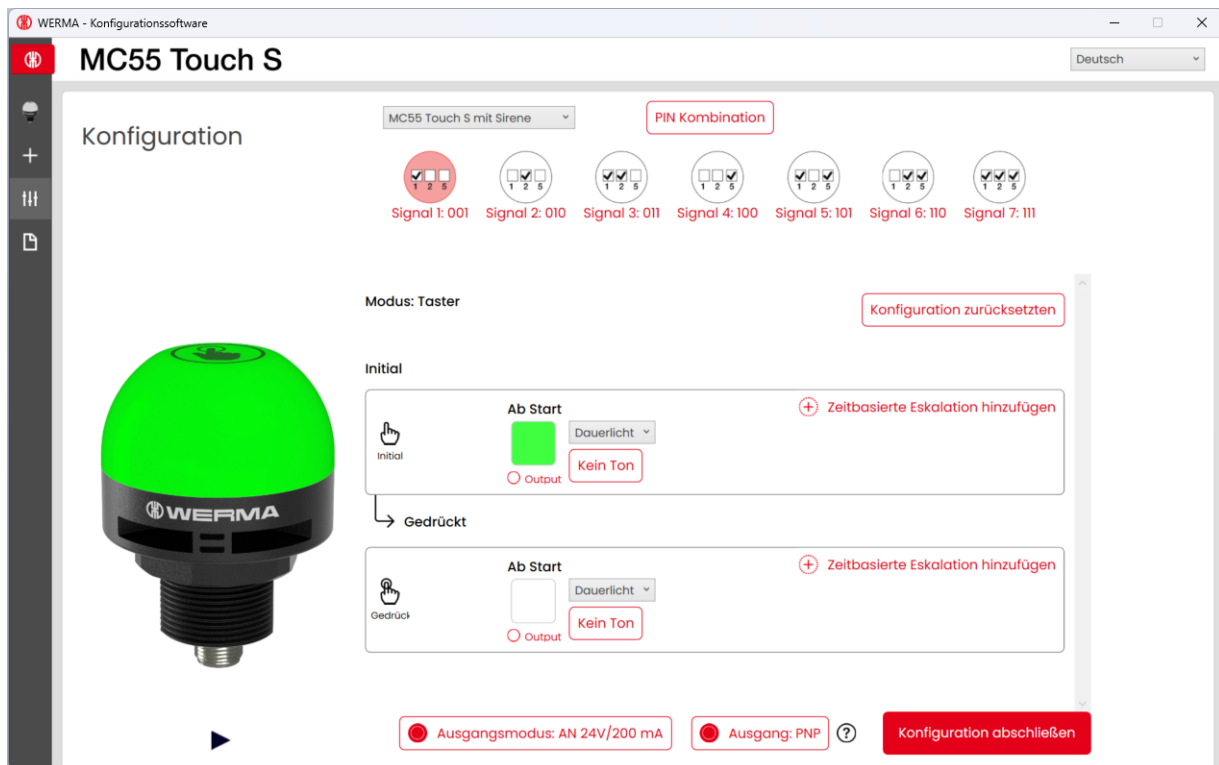

Im Modus **Taster** können 2 Zustände konfiguriert werden.

- Initial: Ist aktiv, wenn beim entsprechenden Signaleingang Strom anliegt und der MC55 Touch S nicht gedrückt wird.
- Gedrückt: Ist aktiv, wenn MC55 Touch S gedrückt und gedrückt gehalten wird.
- Sobald der MC55 Touch S nicht mehr gedrückt wird, ist wieder der Zustand Initial aktiv.

Für jeden Zustand können die Einstellungen für die Farbe, das Leuchtbild, die Sirene (falls vorhanden), die zeitbasierte Eskalation und der Ausgang angepasst werden.

5.5.2.2 Modus Schalter

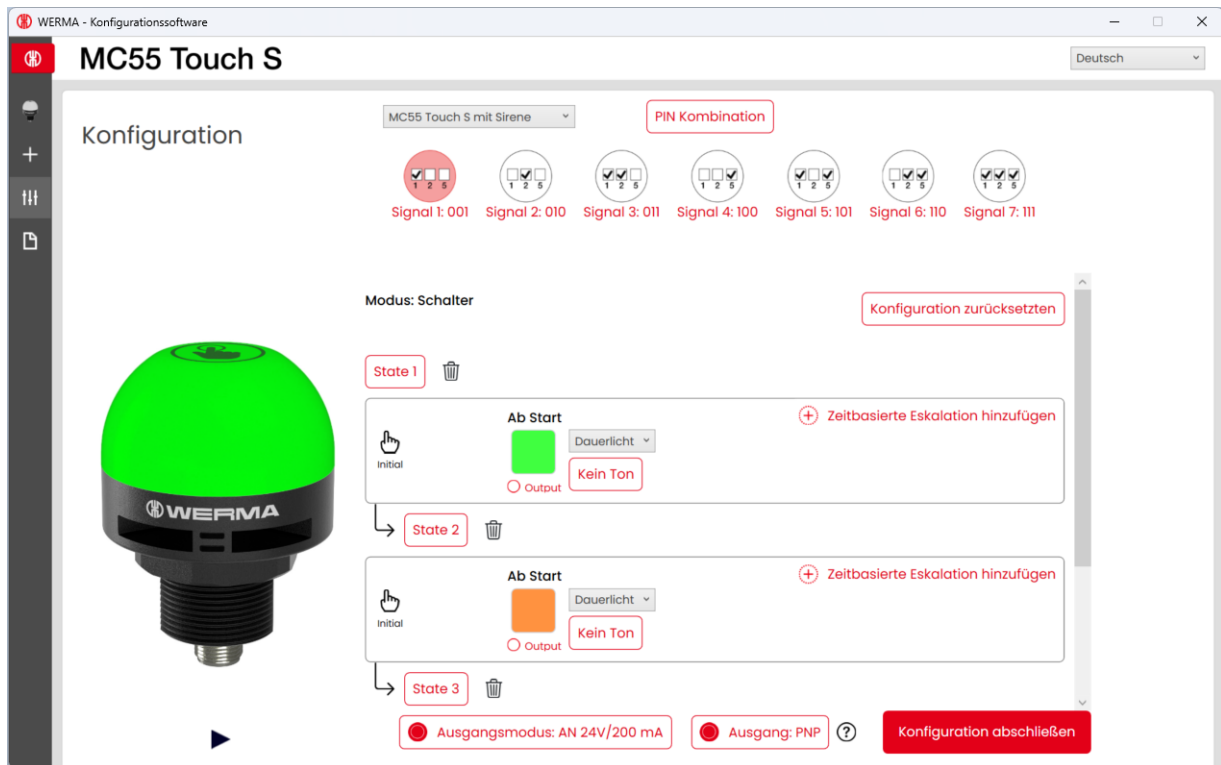

Im Modus **Schalter** können max. 10 Zustände konfiguriert werden. Nach jedem Druck auf den MC55 Touch S wird der nächste Zustand aktiviert.

Im Modus **Schalter** leuchtet der MC55 Touch S beim Wechsel zwischen den Zuständen kurz weiß, um ein Feedback für die Erkennung des Touch Inputs zu geben.

Für jeden Zustand können die Einstellungen für die Farbe, das Leuchtbild, die Sirene (falls vorhanden), die zeitbasierte Eskalation und der Ausgang angepasst werden.



Der MC55 Touch S wird standardmäßig im Schaltermodus ausgeliefert. Bei Aktivierung des Touch-Inputs werden am Ausgang 24 V geschaltet.

1. Im gewünschten Signaleingang auf **Konfiguration zurücksetzen** klicken.

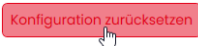

2. **Modus: Taster** oder **Modus: Schalter** wählen.

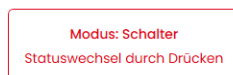
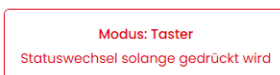

5.5.3 Zustände anpassen

Zustände können ausschließlich im Modus **Schalter** hinzugefügt, gelöscht oder umbenannt werden. Im Modus **Taster** sind die beiden möglichen Zustände vorgegeben.

5.5.3.1 Zustand hinzufügen

1. Auf **Zustand hinzufügen** klicken.

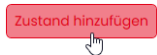

5.5.3.2 Zustand entfernen

1. Neben dem zu entfernenden Zustand (z. B. **State 3**) auf  klicken.



5.5.3.3 Zustand umbenennen

1. Auf den Zustand (z. B. **State 1**) klicken.
→ Das Fenster **State 1** erscheint.

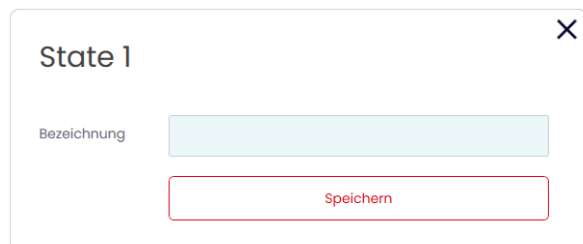
A dialog box titled "State 1" with a close button (X) in the top right corner. Inside the dialog, there is a label "Bezeichnung" followed by a light blue text input field. Below the input field is a red rectangular button with the text "Speichern" in white.

2. Im Feld **Bezeichnung** die gewünschte Bezeichnung des Zustands eingeben.
3. Auf **Speichern** klicken.

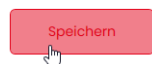

5.5.4 Farbe wählen

Jeder Stufe kann eine vorgegebene Standardfarbe oder eine individuelle Farbe zugewiesen werden.

1. In der Spalte **Farbe** auf das Farbfeld klicken.



→ Das Fenster **Farbe auswählen** erscheint.



2. Wählen, ob eine Standardfarbe oder eine individuelle Farbe verwendet werden soll.

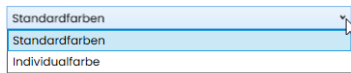

5.5.4.1 Standardfarbe

3. Auf das gewünschte Farbfeld klicken.



Folgende 8 Standardfarben stehen zur Verfügung:

- rot
- gelb
- grün
- weiß
- blau
- hellgelb
- violett
- türkis

5.5.4.2 Individualfarbe

4. Gewünschte Farbe im Farbfeld auswählen oder den entsprechenden RGB-Wert in den Feldern **Rot**, **Grün** und **Blau** eingeben.

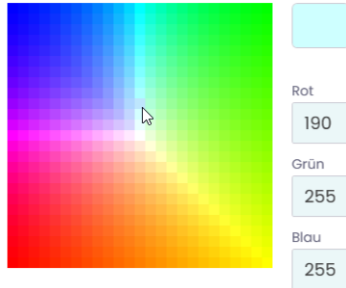

5. Auf **Farbe auswählen** klicken.



5.5.5 Leuchteffekt wählen

1. Neben dem Farbfeld auf das Auswahlmü klicken und den gewünschten Leuchteffekt wählen.

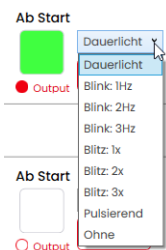

Folgenden 8 Leuchteffekte stehen zur Verfügung:

- Dauerlicht
- Blink 1Hz
- Blink 2Hz
- Blink 3Hz
- Blitz 1x
- Blitz 2x
- Blitz 3x
- Pulsierend
- Ohne



Die Einstellung **Ohne** kann gewählt werden, falls die Pin-Belegung nur für Ton oder für Dauerstromversorgung verwendet werden soll.

5.5.6 Sirene wählen

Falls der angeschlossene oder gewählte MC55 Touch S eine Sirene hat, kann ein Signalton gewählt werden, der bei Aktivierung des Zustands ertönt.

1. Im gewünschten Zustand auf **Kein Ton** klicken.

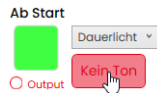



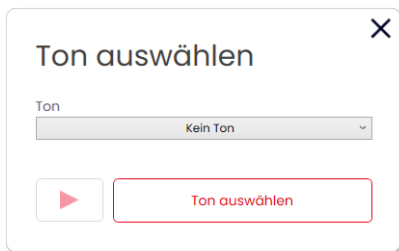





→ Das Fenster **Ton auswählen** erscheint.

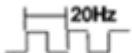

2. Den gewünschten **Ton** wählen.

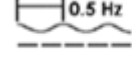
Folgende 10 Tonarten stehen zur Verfügung:

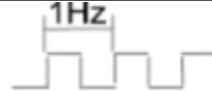
Ton	Frequenz	Beschreibung	Max. dB (A)
1	 3.8 kHz	Dauerton	86
2	 0.9 kHz	Dauerton	70
3	 2.1 kHz	Pulston	67
4	 0.9 kHz	Pulston	68
5	 2.65 kHz	Pulston	66
6	 0.9 kHz	Pulston	70
7	 3.8 kHz	Pulston	87
8	 2.3 kHz - 3.6 kHz	Wobbelton	89
9	 2.65 kHz	Dauerton	67
10	 1.2 kHz - 0.8 kHz	Wechselton	78

- i** Der gewählte Ton kann über die Schaltfläche ▶ in der Tonauswahl getestet werden. Der Ton wird dabei über den Computer abgespielt.

- 3.** Auf **Ton auswählen** klicken.

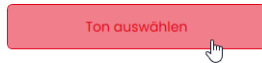

5.5.7 Zeitbasierte Eskalation anpassen

Für jeden Zustand im Modus **Schalter** oder im Modus **Taster** können maximal zwei zeitbasierte Eskalationen konfiguriert werden.

Sobald eine zeitbasierte Eskalation konfiguriert wurde, wird nach Ablauf der eingestellten Zeit die nächste Eskalation aktiviert.

Für jede Eskalation können die Zeit, das Leuchtbild, die Farbe, die Sirene (falls vorhanden) und der Ausgang konfiguriert werden.

5.5.7.1 Zeitbasierte Eskalation hinzufügen

- 1.** Auf **Zeitbasierte Eskalation hinzufügen** klicken.



→ Eine Eskalationsstufe wurde hinzugefügt.



- 2.** Auf **Nach 10s** klicken.
→ Das Fenster **Nach 10s** erscheint.

Nach 10s
✕

Zeit zur Eskalation (s)

Wertebereich: 0,1 bis 3600 Sekunden

Speichern

- 3.** Im Feld **Zeit zur Eskalation (s)** eingeben, nach wie vielen Sekunden die Eskalationsstufe starten soll.

4. Auf **Speichern** klicken.

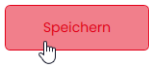

5. Weitere Eigenschaften (Farbe, Leuchtbild, Ausgang, Ton) der Eskalationsstufe wie gewünscht anpassen.

6. Bei Bedarf durch Klicken auf  eine weitere Eskalationsstufe hinzufügen.

5.5.7.2 Zeitbasierte Eskalation entfernen

Bei Bedarf kann die jeweils letzte Eskalationsstufe entfernt werden.

1. In der letzten Eskalationsstufe auf **Entfernen** klicken.



5.5.8 Ausgang aktivieren

Für jede Stufe und jede einzelne Eskalationsstufe kann der digitale 24V-Ausgang des MC55 Touch S aktiviert werden.

1. In der gewünschten Stufe oder Eskalationsstufe die Option **Output** aktivieren.



2. Bei Bedarf zwischen **Ausgangsmodus: AN 24V/200 mA** und **Ausgangsmodus: PULS 24V/200 mA** umschalten.

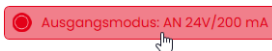

Im Modus **Puls** wird ein Puls von min. 100 ms am Ausgang angelegt.

3. Bei Bedarf zwischen **Ausgang: PNP** und **Ausgang: NPN** umschalten.

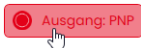

Hinweis

Beschädigung des MC55 Touch S

Der MC55 Touch S kann beschädigt werden, wenn der Ausgang falsch konfiguriert wird.

1. Sicherstellen, dass der Ausgang des MC55 Touch S passend zum angeschlossenen Gerät oder zur angeschlossenen Maschine konfiguriert ist.

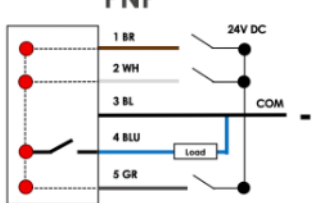
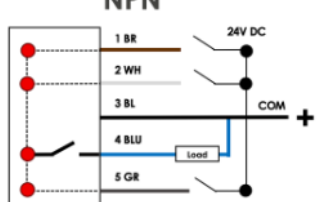
Schaltung	Beschreibung
PNP	<div style="display: flex; align-items: center;"> <div style="writing-mode: vertical-rl; transform: rotate(180deg); margin-right: 10px;">MC55 Touch</div> <div style="text-align: center;"> <p>PNP</p>  </div> <div style="margin-left: 20px;"> <ul style="list-style-type: none"> – Positiv schaltend – Positive Last wird auf den Ausgang geschaltet. </div> </div>
NPN	<div style="display: flex; align-items: center;"> <div style="writing-mode: vertical-rl; transform: rotate(180deg); margin-right: 10px;">MC55 Touch</div> <div style="text-align: center;"> <p>NPN</p>  </div> <div style="margin-left: 20px;"> <ul style="list-style-type: none"> – Negativ schaltend – Negative Last ist mit dem Ausgang verbunden. </div> </div>

5.5.9 Ansteuerung simulieren

Nachdem alle Einstellungen vorgenommen wurden, kann die Ansteuerung simuliert werden.

Die Simulation stellt die Leuchteffekte, zeitbasierten Eskalationen, den Output sowie durch ein Symbol die Tonausgabe dar.

1. Unter dem Bild des MC55 Touch S auf ► klicken.
→ Das Bild des MC55 Touch S zeigt den Initialzustand und, falls konfiguriert, nach Ablauf der entsprechenden Zeit die Eskalationsstufen.
2. Auf **Touch Button** klicken, um Drücken des MC55 Touch S zu simulieren.
3. Das Bild des MC55 Touch S zeigt das konfigurierte Verhalten.
4. Unter dem Bild des MC55 Touch S auf ■ klicken, um die Simulation zu stoppen.

5.5.10 Konfiguration abschließen

1. Bei Bedarf weitere Änderungen an der Konfiguration vornehmen.
2. Sobald alle Stufen wie gewünscht konfiguriert sind, auf **Abschließen** klicken.
→ Das Fenster **Abschließen** erscheint.



3. Auf **Speichern** klicken, um die Konfiguration in einer Konfigurationsdatei zu speichern.
4. Auf **Auf Gerät übertragen** klicken, um die Konfiguration auf den angeschlossenen MC55 Touch S zu übertragen.
5. Auf **PDF-Konfigurationsblatt anzeigen** klicken, um eine Übersicht der aktuellen Konfiguration anzuzeigen.
6. Auf **PDF-Konfigurationsblatt speichern** klicken, um die Übersicht der aktuellen Konfiguration als PDF-Datei zu speichern.

5.6 Konfiguration aus Beispielvorlagen übernehmen

Die WERMA - Konfigurationssoftware stellt verschiedene vordefinierte Konfigurationen bereit, die direkt auf einen angeschlossenen MC55 Touch S übertragen oder als Grundlage für eigene Konfigurationen verwendet werden können.

Folgende Vorlagen stehen zur Verfügung:

Vorlage	Beschreibung
Taster Konfiguration	<ul style="list-style-type: none"> – MC55 Touch S wird als Taster konfiguriert. – Solange der MC55 Touch S gedrückt gehalten wird, werden ein anderer Zustand und der Output im Modus „An“ aktiviert. – Für jeden Signaleingang wird eine andere Farbe verwendet. <p>Mögliche Anwendung:</p> <ul style="list-style-type: none"> – Weiteres Gerät soll nur während des Drucks auf den MC55 Touch S aktiviert werden.
Schalter Konfiguration	<ul style="list-style-type: none"> – MC55 Touch S wird als Schalter konfiguriert. – Beim Druck auf den MC55 Touch S werden ein anderer Zustand und der Output im Modus „An“ aktiviert. – Für jeden Signaleingang wird eine andere Farbe verwendet. – Maximal 10 Zustände können für jeden Signaleingang angelegt werden. <p>Mögliche Anwendung:</p> <ul style="list-style-type: none"> – Feedback mithilfe des Puls-Ausgangs an eine Steuerung geben und dabei den Zustand des MC55 Touch S wechseln oder ein weiteres Gerät schalten/ausschalten.
Konfiguration zeitbasierte Eskalation	<ul style="list-style-type: none"> – MC55 Touch S wird als Taster konfiguriert. – Nach 60 Sekunden blinkt der MC55 Touch S rot und der Output wird im Modus "An" aktiviert. – Maximal 2 zeitliche Eskalationen pro Zustand können konfiguriert werden. <p>Mögliche Anwendung:</p> <ul style="list-style-type: none"> – Wenn nach einer gewisser Zeit ein Fehler nicht quittiert wird, kann eine Tonausgabe dazu geschaltet werden und durch Drücken des MC55 Touch S wieder quittiert werden. – Zeitkritische Arbeitsschritte über die Veränderung des Leuchtbilds visualisieren.

Vorlage	Beschreibung
IO-Block Kompatibel	<ul style="list-style-type: none"> – MC55 Touch S wird als Schalter konfiguriert. <p>Mögliche Anwendung:</p> <ul style="list-style-type: none"> – IO-Block – Signaleingang 1 ist 24 V. – Signaleingang 3 ist COM. – Signaleingänge 2 und 4 zeigen unterschiedliche Farben an.

1. Im Bereich **Konfiguration** auf **Aus Beispielvorlagen übernehmen** klicken.

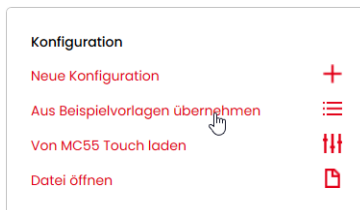

→ Das Fenster **Konfiguration aus Beispielvorlagen übernehmen** erscheint.

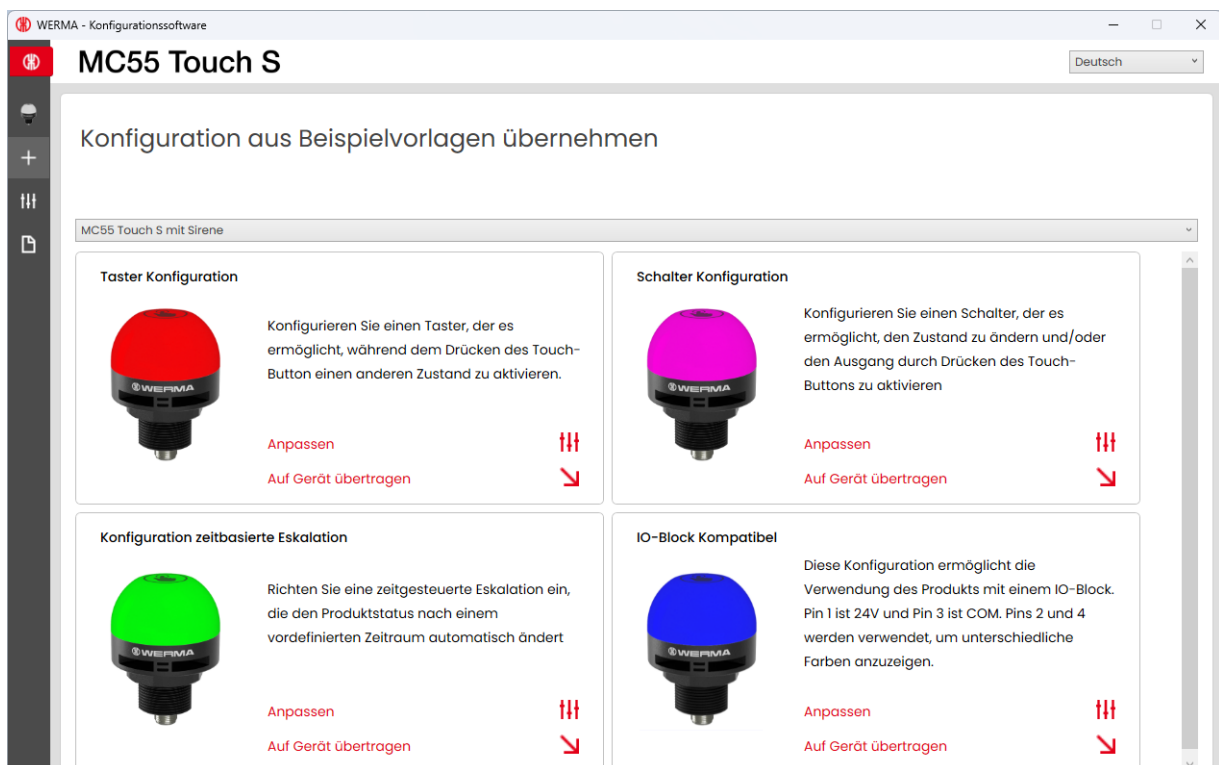

2. Variante des MC55 Touch S wählen.

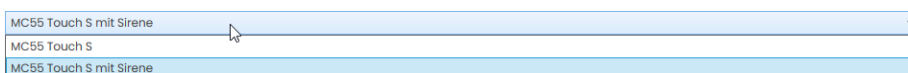

3. In der gewünschten Vorlage auf **Anpassen** klicken, um die Vorlage zu laden und weiter zu bearbeiten.
4. Auf **Auf Gerät übertragen** klicken, um die Vorlage zu laden und direkt auf den angeschlossenen MC55 Touch S zu übertragen.

 Für weitere Informationen zur Konfiguration, siehe "Neue Konfiguration erstellen", S. 74.

5.7 Konfiguration vom angeschlossenen MC55 Touch S laden

Falls ein MC55 Touch S am Computer angeschlossen ist, bietet die WERMA - Konfigurationssoftware die Möglichkeit, die aktuelle Konfiguration (ggf. Auslieferungszustand) zur Bearbeitung zu öffnen. Falls kein MC55 Touch S angeschlossen ist, ist dieser Menüpunkt verblasst.

1. Im Bereich **Konfiguration** auf **Von MC55 Touch laden** klicken.

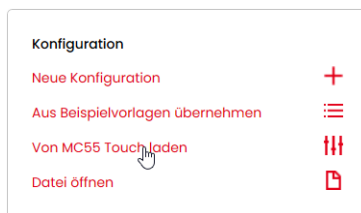

→ Das Fenster **Konfiguration** erscheint im eingestellten Modus und ist bereits mit der aktuellen Konfiguration befüllt.

 Für weitere Informationen zur Konfiguration, siehe "Neue Konfiguration erstellen", S. 74.

5.8 Bestehende Konfiguration öffnen

1. Im Bereich **Konfiguration** auf **Datei öffnen** klicken.



2. Gewünschte Konfigurationsdatei wählen und auf **Öffnen** klicken.



Alternativ können über das Seitenmenü die zuletzt verwendeten Konfigurationen angezeigt werden (siehe "Überblick", S. 72).

5.9 Firmware aktualisieren



Um eine Firmware-Aktualisierung durchführen zu können, muss der Computer mit dem Internet verbunden und ein MC55 Touch S angeschlossen sein.

1. Im Bereich **Firmware** auf **Auf neue Firmware prüfen** klicken.



- Die WERMA - Konfigurationssoftware sucht nach Firmware-Aktualisierungen für den angeschlossenen MC55 Touch S.
- Falls eine Aktualisierung gefunden wurde, erscheint eine entsprechende Meldung.

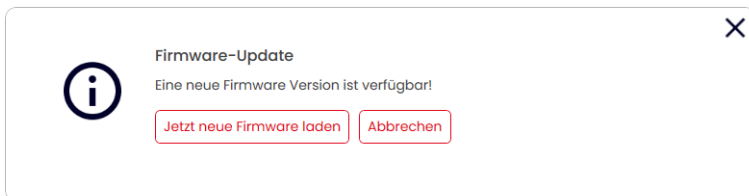

2. Auf **Jetzt neue Firmware laden** klicken.

- Die neue Firmware wird auf den angeschlossenen MC55 Touch S übertragen.

6 WERMA - Konfigurationssoftware aktualisieren



Um eine Software-Aktualisierung durchführen zu können, muss der Computer mit dem Internet verbunden sein.

1. Im Bereich **Diese Software** auf **Auf neue Version prüfen** klicken.

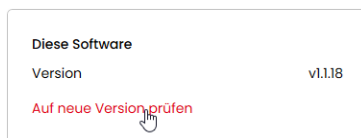

- Die WERMA - Konfigurationssoftware sucht nach Software-Aktualisierungen.
- Falls eine Aktualisierung gefunden wurde, erscheint eine entsprechende Meldung.

7 Support



WERMA Signaltechnik GmbH + Co.KG

D-78604 Rietheim-Weilheim

Support : +49 (0)7424 / 9557-222

Fax: +49 (0)7424 / 9557-44

support@werma.com

www.werma.com



Manual

WERMA - Configuration Software

Version: 3.0 - 10/2024

310.657.006

Legal notice

Any mention of company names is solely for instruction purposes. Reference to existing organisations is not intended, except for the companies below. The following companies and brands are mentioned in the Manual:

- Microsoft Windows 10 and Windows 11 are trademarks of the Microsoft Corporation.

WERMA reserves the right to make technical changes to the product and accepts no responsibility for any mistakes or printing errors in this documentation.

© Copyright 2024, WERMA Signaltechnik GmbH + Co.KG.

All rights reserved.

WERMA Signaltechnik GmbH + Co.KG

78604 Riethem-Weilheim, Germany

Phone: +49 (0)7424 / 9557-222

Fax: +49 (0)7424 / 9557-44

support@werma.com

www.werma.com

Table of Contents

1 Overview	97
1.1 Function	97
1.2 System requirements	97
2 Installing the WERMA - Configuration Software	98
3 Starting the WERMA - Configuration Software	98
4 Configuring the eSIGN	99
4.1 Function	99
4.2 Hardware description	99
4.2.1 Overview of the connection area	100
4.2.2 Overview of the 8-pin M12 connector	101
4.3 Overview	102
4.3.1 Configuration area	103
4.3.2 Device Information area	103
4.3.3 Support area	103
4.3.4 This software area	103
4.3.5 Firmware area	103
4.4 Setting the language	103
4.5 Creating a new configuration	104
4.5.1 Autoscale mode	106
4.5.2 Signal tower mode	116
4.5.3 Filling level mode	126
4.5.4 Individual mode	140
4.6 Creating a configuration from sample templates	153
4.7 Loading the configuration of the connected eSIGN	154
4.8 Opening an existing configuration	155
4.9 Updating the firmware	156
5 Configuring the MC55 Touch S	157
5.1 Function	157
5.2 Hardware description	157
5.2.1 Overview of the connection area	157
5.2.2 Overview of the 5-pin M12 connector	158
5.2.3 Default setting	158
5.3 Overview	159
5.3.1 Configuration area	160
5.3.2 Device Information area	160
5.3.3 Support area	160
5.3.4 This software area	160
5.3.5 Firmware area	160

- 5.4 Setting the language 160
- 5.5 Creating a new configuration 161
 - 5.5.1 Selecting a signal input 163
 - 5.5.2 Changing the mode 164
 - 5.5.3 Modifying states 166
 - 5.5.4 Selecting a colour 167
 - 5.5.5 Selecting a light pattern 168
 - 5.5.6 Selecting a siren 169
 - 5.5.7 Modifying a time-based escalation 170
 - 5.5.8 Enabling the output 173
 - 5.5.9 Simulating signal inputs 174
 - 5.5.10 Finalising a configuration 174
- 5.6 Creating a configuration from sample templates 175
- 5.7 Loading the configuration of the connected MC55 Touch S 177
- 5.8 Opening an existing configuration 178
- 5.9 Updating the firmware 178

- 6 Updating the WERMA - Configuration Software 179**

- 7 Support 180**

1 Overview

1.1 Function

The WERMA - Configuration Software can be used to configure the following WERMA devices:

- eSIGN signal tower
- MC55 Touch S

 The devices available are market-dependent.

1.2 System requirements

Operating system	Windows 10 x86/x64 Windows 11 Up-to-date Windows updates are a compulsory requirement.
USB port	Required for the hardware configuration.

 Supported operating systems are only supported for as long as Microsoft also supports them through the Microsoft Support Lifecycle.

2 Installing the WERMA - Configuration Software

The WERMA - Configuration Software does not need to be installed and runs as a portable version.

1. Download the WERMA - Configuration Software from the following website:
www.werma.com/software.

3 Starting the WERMA - Configuration Software

1. Double-click on `Werma-Konfigurator.exe`.
→ The WERMA - Configuration Software starts.



2. Select the desired device.

4 Configuring the eSIGN

4.1 Function

The new eSIGN brings new dimensions to light. Electronic modularity enables the product to create a variety of signal modes with various colours, brightness levels and light effects, from the classic signal tower to completely customised settings. The eSIGN can also switch with ease between variable filling level indications or full-surface signalling. In addition to providing you with an overview of your process cycles, this also opens up completely new options.

The WERMA - Configuration Software can be used to configure the individual segments of WERMA eSIGN and to transfer the configuration to the eSIGN.

The configuration can be performed with or without connecting an eSIGN. If no eSIGN is connected, the configuration can be saved in a configuration file and later loaded and transferred to a connected eSIGN.

4.2 Hardware description

The hardware information applies to the following part numbers:

- 657.0x0.55 & 657.2x0.55 - 9 segments
- 657.1x0.55 & 657.3x0.55 - 9 segments with a siren
- 657.5x0.55 & 657.7x0.55 - 15 segments
- 657.6x0.55 & 657.8x0.55 - 15 segments with a siren

4.2.1 Overview of the connection area

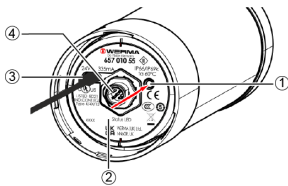

Item	Description
1	User button
2	Status LED
3	USB-C connection
4	8-pin M12 connector

LED status	Description
LED flashes yellow	Normal operation
LED pulses	Firmware update is being installed
LED is off	USB-C cable not properly connected

i The user button is not functional in the current eSIGN version and is kept available for future functional enhancements.

4.2.2 Overview of the 8-pin M12 connector

The eSIGN is connected via an 8-pin M12 connector with the following assignment:

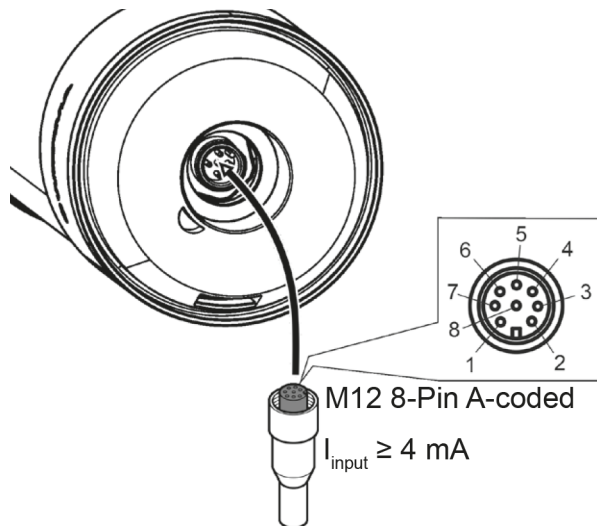

M12 pin assignment	Wire colour of M12 cable	Function
1	white	Signal 1
2	brown	Signal 2
3	green	Signal 3
4	yellow	Signal 4
5	grey	Signal 5
6	pink	Signal 6
7	blue	COM
8	red	+24 V

4.3 Overview

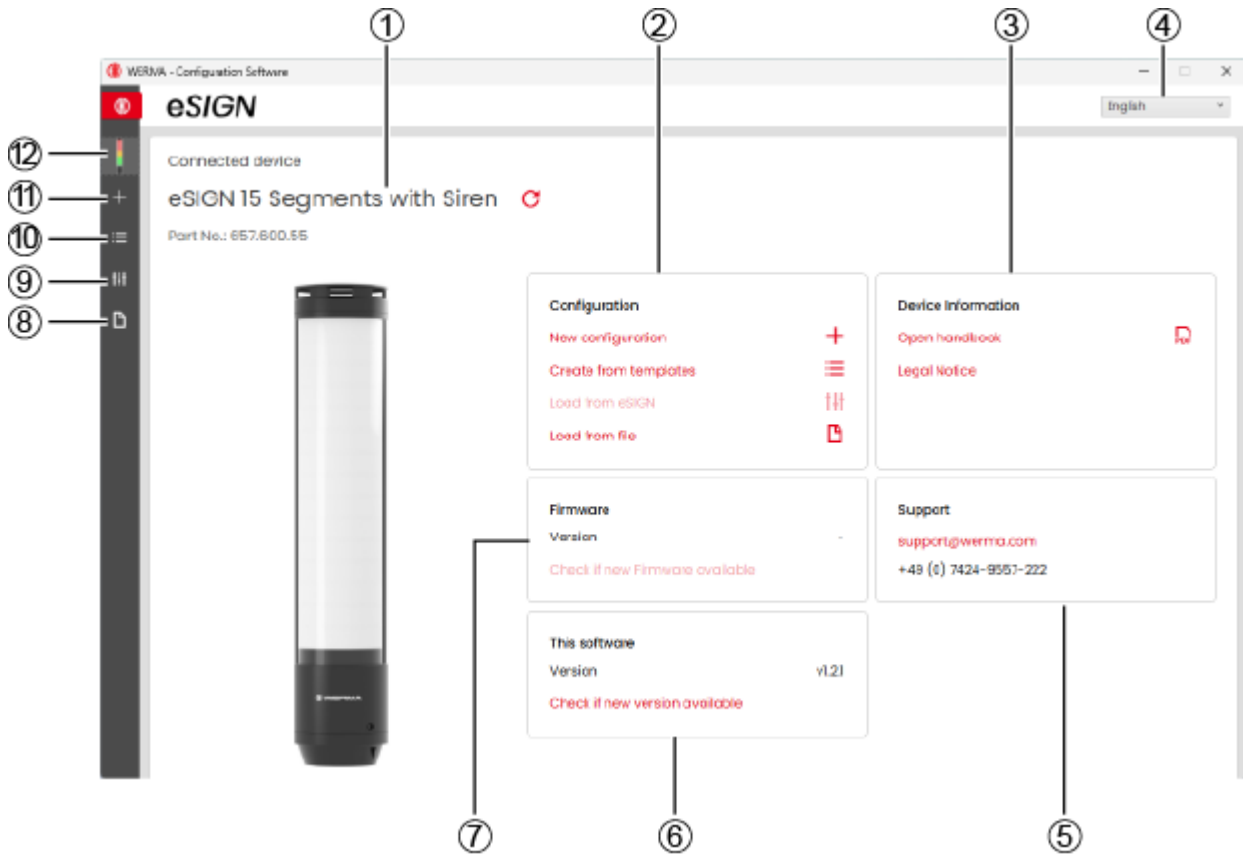

Item	Description
1	Variant of the connected eSIGN
2	Configuration area
3	Device Information area
4	Setting the language
5	Support area
6	This software area
7	Firmware area
8	Opening an existing configuration
9	Loading a configuration from the eSIGN
10	Creating a configuration from sample templates
11	Creating a new configuration
12	Opening the start screen
13	Device selection

4.3.1 Configuration area

The following options for creating a configuration are available in the **Configuration** area:

- **New configuration:** Create a new configuration (see "Creating a new configuration", S. 104).
- **Create from templates:** Open standard templates that can be transferred to the device immediately (see "Creating a configuration from sample templates", S. 153).
- **Load from eSIGN:** Open the current configuration (for example the default setting) for editing (see "Loading the configuration of the connected eSIGN", S. 154).
- **Load from file:** Open and reuse an existing configuration (see "Opening an existing configuration", S. 155).

4.3.2 Device Information area

The manual and legal information can be opened in the **Device Information** area.

4.3.3 Support area

The **Support** area displays the contact information of the WERMA support team.

4.3.4 This software area

The **This software** area displays information about the version status of the WERMA - Configuration Software and offers a possibility to update the configuration software.

4.3.5 Firmware area

The **Firmware** area displays information about the firmware of the connected eSIGN and offers a possibility to update the firmware.

4.4 Setting the language

1. Select the desired language in the selection menu.

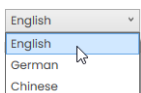

4.5 Creating a new configuration

i The configuration can be performed with or without connecting an eSIGN.

i The eSIGN can be connected simultaneously to a computer via the USB cable and to the 24 V power supply via the M12 cable.

1. Use the USB cable to connect the eSIGN to the computer.
→ The WERMA - Configuration Software detects the connected eSIGN.

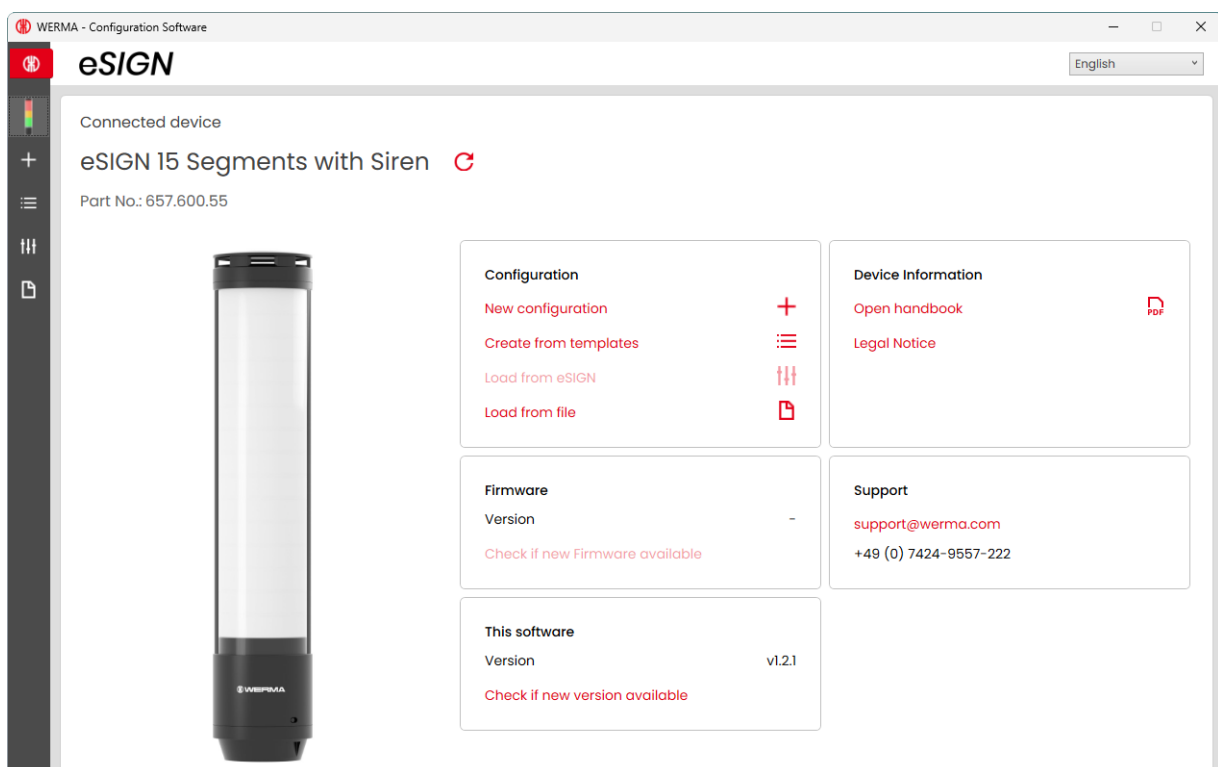

2. If the WERMA - Configuration Software does not detect the connected eSIGN: Click on **Refresh connected device**.

No Device connected 

3. Click on **New configuration** in the **Configuration** area.

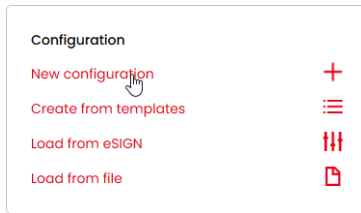

→ The **Create a new configuration** screen appears.

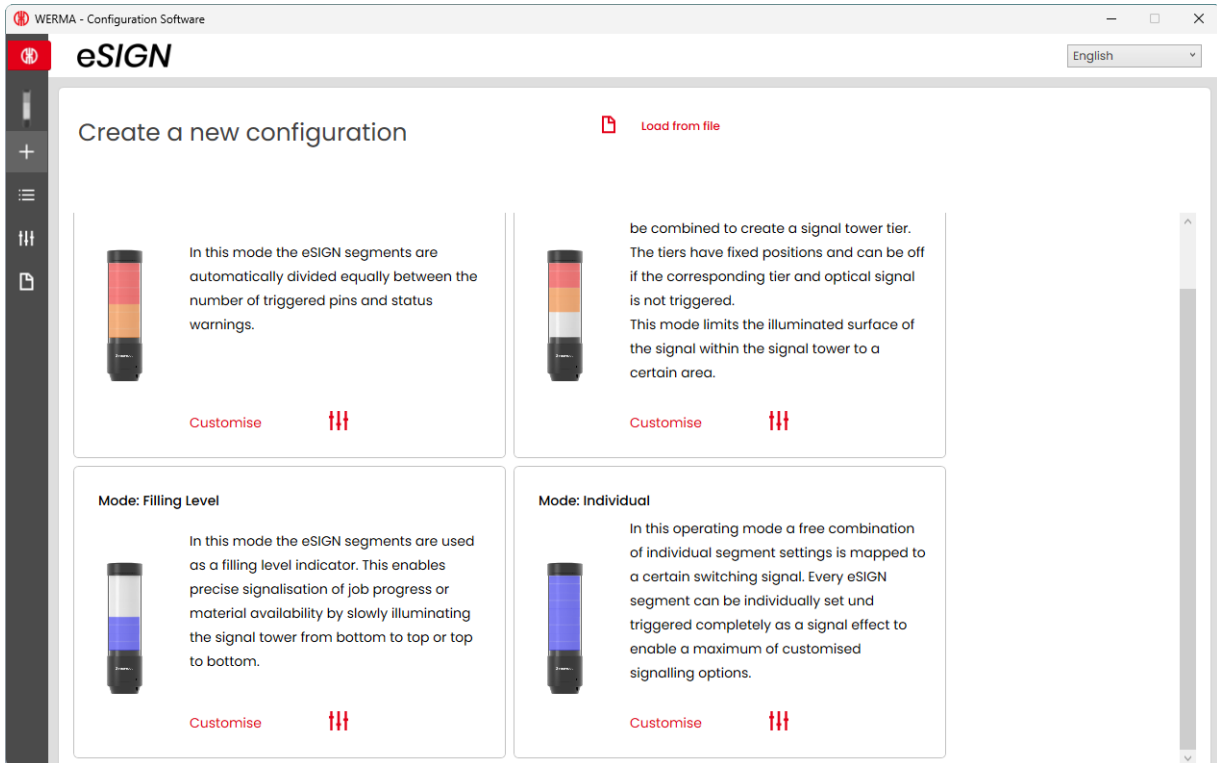

4. Depending on the desired configuration mode, click on **Customise** in the **Mode: Autoscale**, **Mode: Signal Tower**, **Mode: Filling Level** or **Mode: Individual** area.



4.5.1 Autoscale mode



eSIGN segments are automatically divided equally between the number of triggered pins and status messages.

This enables the full potential of the eSIGN to be exploited by providing full-surface illumination. If for example only one status message is active then the entire surface of the eSIGN is illuminated in one colour for maximum visibility.

If several status warnings are active, the illuminated area is split proportionally. If the segments cannot be divided equally then the highest priority colour (highest position in the signal tower) receives the remaining segment. If several segments remain, they will be divided equally according to their prioritisation (position in the signal tower from top to bottom).

Pos.	Colour	Light Effect	Brightness	Siren	Pin
+	Red	Continuous	[Slider]	[Icon]	Pin 3: Input 3
+	Orange	Continuous	[Slider]	[Icon]	Pin 2: Input 2
+	Green	Continuous	[Slider]	[Icon]	Pin 1: Input 1
+					



If necessary, the orientation of the displayed signal tower can be rotated by 180° with the **Switch mounting position** button.

-
-  If necessary (for example, to take into account the power limits of control outputs), the power consumption of the eSIGN can be reduced with the **Power Limitation** button. In this case, the current power requirement of the tower is reduced to less than 500 mA. As a result, the optical signals' brightness or the audible signals' volume is reduced.
-

The **Autoscale** mode is the default operating mode at the time of delivery and is set as follows:

- Variants with 9 segments:
 - 3 tiers red/yellow/green
 - Continuous light
- Variants with 15 segments:
 - 5 tiers red/yellow/green/white/blue
 - Continuous light

The default setting deviates from this standard for customer-specific versions and is documented separately.

4.5.1.1 Selecting a eSIGN variant

The variant is pre-selected accordingly if an *SIGNe* has been connected. If no eSIGN has been connected, the variant of the eSIGN to be configured can be selected.

1. If necessary, select the variant of the eSIGN to be configured.

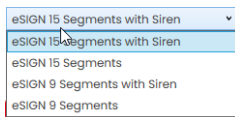

4.5.1.2 Adding or removing a tier

As soon as a tier is added or removed in **Autoscale** mode, the individual eSIGN segments are automatically re-divided and evenly distributed across all tiers. If the segments cannot be divided equally then the highest priority colour (highest position in the signal tower) receives the remaining segment. If several segments remain, they will be divided equally according to their prioritisation (position in the signal tower from top to bottom).

Adding a tier

1. Click on **Add**.



x

→ A tier has been added.

Removing a tier

1. Click on **Delete**.



→ A tier has been removed.

4.5.1.3 Moving a tier

The individual tiers can be moved up or down as required.

1. Click on the Move up or Move down arrow in the **Pos.** column to move the tier up or down.

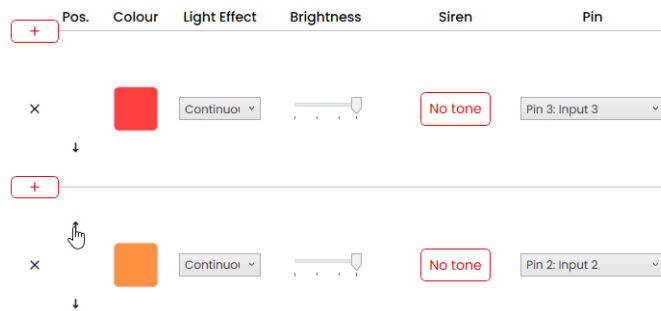

4.5.1.4 Selecting a colour

A standard colour or individual colour can be assigned to every tier.

1. Click on the colour field in the **Colour** column.



→ The **Select colour** window appears.

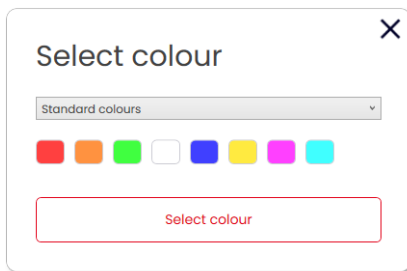

2. Select whether to use a standard colour or an individual colour.

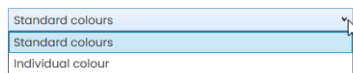

Standard colour

1. Click on the desired colour field.



The following 8 standard colours are available:

- red
- yellow
- green
- white
- blue
- light yellow
- violet
- turquoise

Individual colour

1. Select the desired colour in the colour field or enter the appropriate RGB value in the **Red**, **Green** and **Blue** fields.

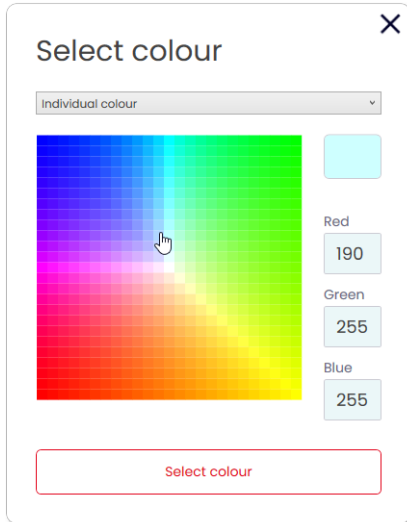

2. Click on **Select colour**.

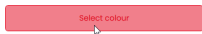

4.5.1.5 Selecting a light pattern

1. Select the desired light pattern in the **Light Effect** column.

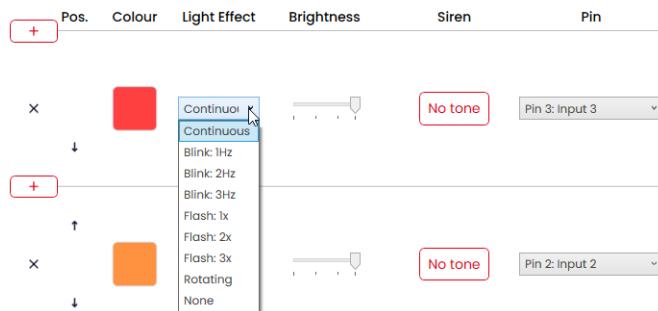

The following 8 light effects are available:

- Continuous light
- Blinking 1 Hz
- Blinking 2 Hz
- Blinking 3 Hz
- Flashing 1x
- Flashing 2x
- Flashing 3x
- Rotating
- None

i The setting **None** can be selected if the tier is only to be configured with a siren.

4.5.1.6 Setting the brightness

1. Set the desired brightness of the tier from the 4 options in the **Brightness** column.



4.5.1.7 Selecting a siren

If the connected or selected eSIGN has a siren, you can select a signal tone which will sound when the tier is enabled.

i If several tiers are set, and the tiers are enabled at the same time, the siren will sound for the colour with the highest priority (highest position within the tower).

1. Click on **No tone** in the **Siren** column.





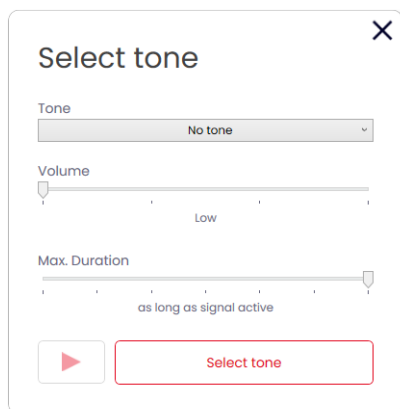



→ The **Select tone** window appears.

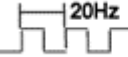
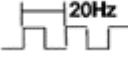
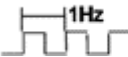

2. Select the desired **Tone** , the desired **Volume** and **Max. Duration**.

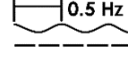
The following 10 tones are available:

Sound	Frequency	Description	Max. dB (A)
1	 2.7 kHz	Continuous tone	104
2	 0.9 kHz	Continuous tone	96
3	 2.8 kHz	Pulse tone	97
4	 0.9 kHz	Pulse tone	93
5	 2.8 kHz	Pulse tone	103
6	 0.9 kHz	Pulse tone	96
7	 2.8 kHz	Pulse tone	104
8	 2.3 kHz- 3.6 kHz	Sweep tone	104
9	 2.6 kHz	Continuous tone	105
10	 1200 Hz 800 Hz	Alternating tone	92



The selected sound can be tested with button ▶ in the selection of tones. The sound is then played by the computer.

3. Click on **Select tone**.

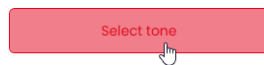

4.5.1.8 Selecting a pin



The fields are pre-configured with a standard configuration, starting from the bottom tier of the tower with pin 1.

Pins that are already in use are shown in grey. The configuration can be changed as required.

1. Select the pin of the 8-pin connector on which the signal to trigger the tier is sent in the **Pin** column.

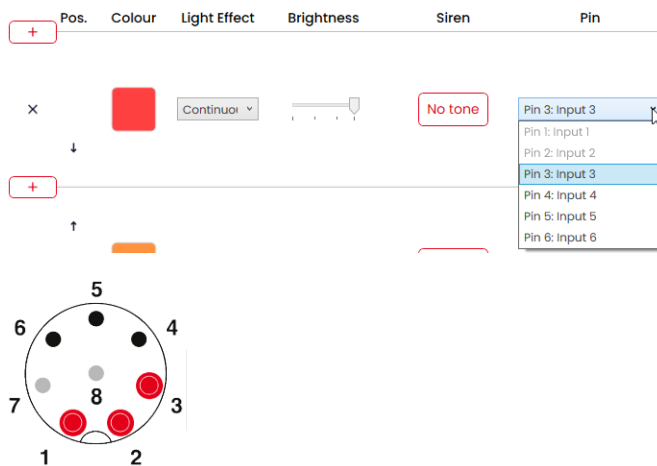

Modifying a pin configuration

If necessary, the assignment of the wire colour to the pin can be changed and a description of the signal added.

1. Click on **PIN Configuration** under the pin overview.



→ The **PIN Configuration** window appears.

PIN Configuration ✕

	Wire Colour	Description
Pin 1: Input 1	<input type="text" value="WH"/>	<input type="text"/>
Pin 2: Input 2	<input type="text" value="BN"/>	<input type="text"/>
Pin 3: Input 3	<input type="text" value="GN"/>	<input type="text"/>
Pin 4: Input 4	<input type="text" value="YE"/>	<input type="text"/>
Pin 5: Input 5	<input type="text" value="GY"/>	<input type="text"/>
Pin 6: Input 6	<input type="text" value="PK"/>	<input type="text"/>
Pin 7: COM	<input type="text" value="BU"/>	<input type="text"/>
Pin 8: +24V	<input type="text" value="RD"/>	<input type="text"/>

2. Enter the desired wire colour in the **Colour** column.
3. Enter the description of the signal in the **Description** column.
4. Click on **Save**.

4.5.1.9 Simulating signal inputs

Once all settings have been made, the signal inputs can be simulated.

1. Click on the pin that enables the desired tier in the pin overview.

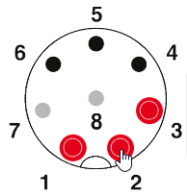

4.5.1.10 Finalising a configuration

1. Make additional changes to the configuration as required.
2. Once all tiers are configured as desired, click on **Finalise**.
→ The **Finalise** window appears.

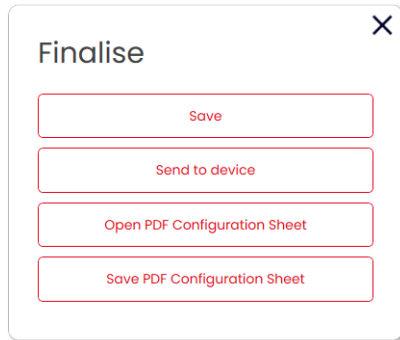

3. Click on **Save** to save the configuration in a configuration file.
4. Click on **Send to device** to transfer the configuration to the connected eSIGN.
5. Click on **Open PDF Configuration Sheet** to display an overview of the current configuration.
6. Click on **Save PDF Configuration Sheet** to save the overview of the current configuration as a PDF file.

4.5.2 Signal tower mode

Individual eSIGN segments can be combined to create a signal tower tier. This enables a classic signal tower to be created in an electronically modular form. In this mode, the tiers have fixed positions and can be off if the corresponding tier and optical signal are not enabled.

This mode limits the illuminated surface of the signal within the signal tower to a certain area.

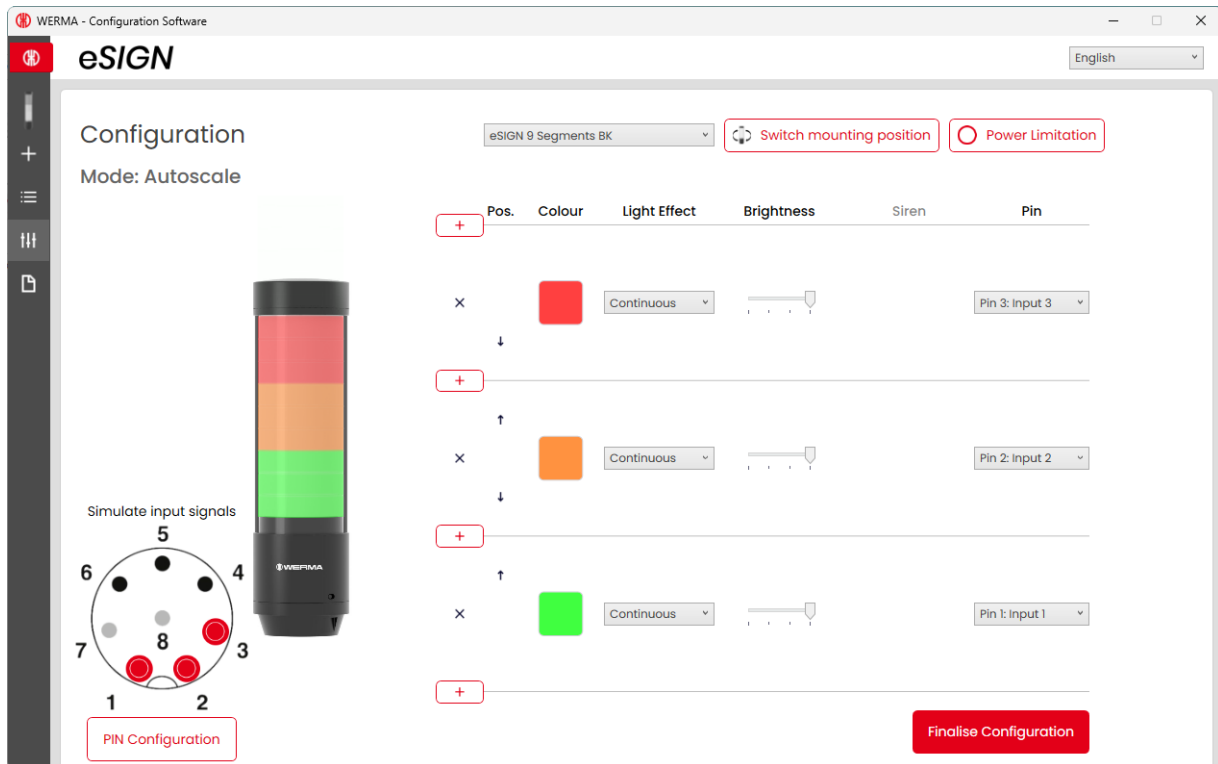

i If necessary, the orientation of the displayed signal tower can be rotated by 180° with the **Switch mounting position** button.

i If necessary (for example, to take into account the power limits of control outputs), the power consumption of the eSIGN can be reduced with the **Power Limitation** button. In this case, the current power requirement of the tower is reduced to less than 500 mA. As a result, the optical signals' brightness or the audible signals' volume is reduced.

4.5.2.1 Selecting a eSIGN variant

The variant is pre-selected accordingly if an *SIGNe* has been connected. If no e*SIGN* has been connected, the variant of the e*SIGN* to be configured can be selected.

1. If necessary, select the variant of the e*SIGN* to be configured.

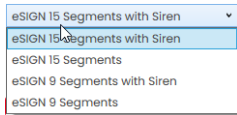

4.5.2.2 Adding or removing a tier

As soon as a tier is added or removed in **Signal Tower** mode, the individual e*SIGN* segments are automatically re-divided and evenly distributed across all tiers.

Adding a tier

1. Click on **Add**.



→ A tier has been added.

Removing a tier

1. Click on **Delete**.



→ A tier has been removed.

4.5.2.3 Moving a tier

The individual tiers can be moved up or down as required.

1. Click on the Move up or Move down arrow in the **Pos.** column to move the tier up or down.

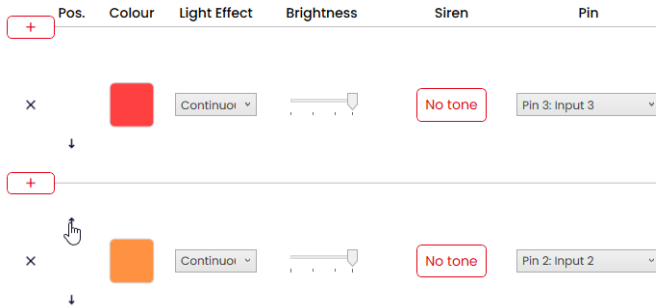

4.5.2.4 Selecting a colour

A standard colour or individual colour can be assigned to every tier.

1. Click on the colour field in the **Colour** column.



→ The **Select colour** window appears.

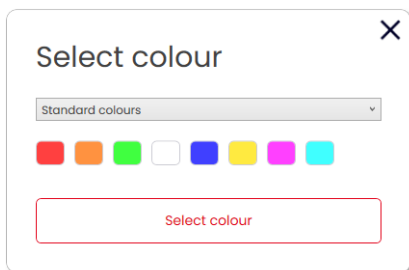

2. Select whether to use a standard colour or an individual colour.

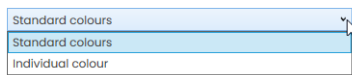

Standard colour

1. Click on the desired colour field.



The following 8 standard colours are available:

- red
- yellow
- green
- white
- blue
- light yellow
- violet
- turquoise

Individual colour

1. Select the desired colour in the colour field or enter the appropriate RGB value in the **Red**, **Green** and **Blue** fields.

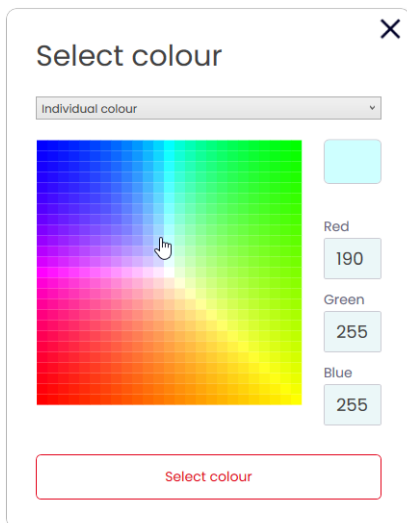

2. Click on **Select colour**.

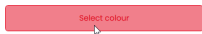

4.5.2.5 Selecting a light pattern

1. Select the desired light pattern in the **Light Effect** column.

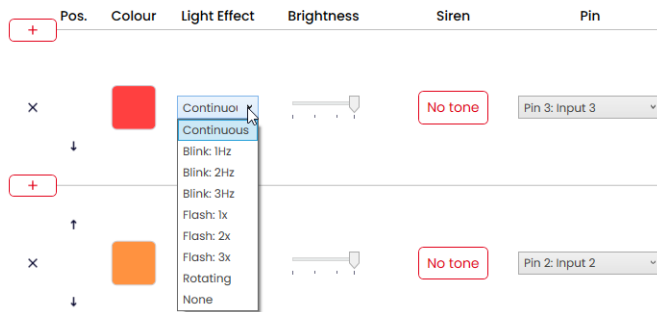

The following 8 light effects are available:

- Continuous light
- Blinking 1 Hz
- Blinking 2 Hz
- Blinking 3 Hz
- Flashing 1x
- Flashing 2x
- Flashing 3x
- Rotating
- None



The setting **None** can be selected if the tier is only to be configured with a siren.

4.5.2.6 Setting the brightness

1. Set the desired brightness of the tier from the 4 options in the **Brightness** column.

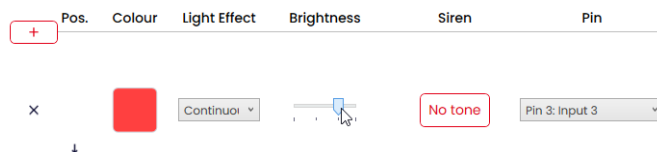

4.5.2.7 Selecting a siren

If the connected or selected eSIGN has a siren, you can select a signal tone which will sound when the tier is enabled.

i If several tiers are set, and the tiers are enabled at the same time, the siren will sound for the colour with the highest priority (highest position within the tower).

1. Click on **No tone** in the **Siren** column.





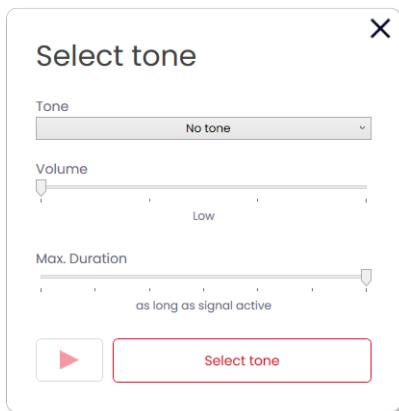

→ The **Select tone** window appears.

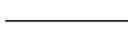

2. Select the desired **Tone**, the desired **Volume** and **Max. Duration**.

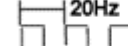
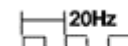
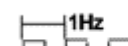
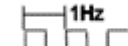
The following 10 tones are available:

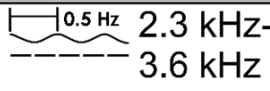
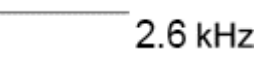
Sound	Frequency	Description	Max. dB (A)
1	 2.7 kHz	Continuous tone	104
2	 0.9 kHz	Continuous tone	96
3	 2.8 kHz	Pulse tone	97
4	 0.9 kHz	Pulse tone	93
5	 2.8 kHz	Pulse tone	103
6	 0.9 kHz	Pulse tone	96
7	 2.8 kHz	Pulse tone	104

Sound	Frequency	Description	Max. dB (A)
8	 2.3 kHz- 3.6 kHz	Sweep tone	104
9	 2.6 kHz	Continuous tone	105
10	 1Hz - 1200 Hz - 800 Hz	Alternating tone	92

 The selected sound can be tested with button ▶ in the selection of tones. The sound is then played by the computer.

3. Click on **Select tone**.

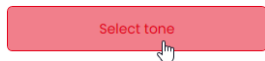

4.5.2.8 Selecting a pin



The fields are pre-configured with a standard configuration, starting from the bottom tier of the tower with pin 1.

Pins that are already in use are shown in grey. The configuration can be changed as required.

1. Select the pin of the 8-pin connector on which the signal to trigger the tier is sent in the **Pin** column.

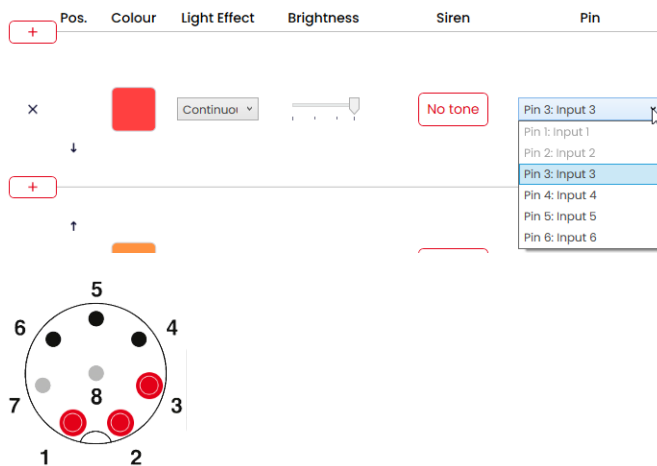

Modifying a pin configuration

If necessary, the assignment of the wire colour to the pin can be changed and a description of the signal added.

1. Click on **PIN Configuration** under the pin overview.



→ The **PIN Configuration** window appears.

PIN Configuration ✕

	Wire Colour	Description
Pin 1: Input 1	<input type="text" value="WH"/>	<input type="text"/>
Pin 2: Input 2	<input type="text" value="BN"/>	<input type="text"/>
Pin 3: Input 3	<input type="text" value="GN"/>	<input type="text"/>
Pin 4: Input 4	<input type="text" value="YE"/>	<input type="text"/>
Pin 5: Input 5	<input type="text" value="GY"/>	<input type="text"/>
Pin 6: Input 6	<input type="text" value="PK"/>	<input type="text"/>
Pin 7: COM	<input type="text" value="BU"/>	<input type="text"/>
Pin 8: +24V	<input type="text" value="RD"/>	<input type="text"/>

2. Enter the desired wire colour in the **Colour** column.
3. Enter the description of the signal in the **Description** column.
4. Click on **Save**.

4.5.2.9 Simulating signal inputs

Once all settings have been made, the signal inputs can be simulated.

1. Click on the pin that enables the desired tier in the pin overview.

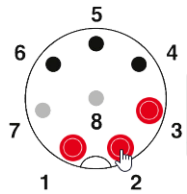

4.5.2.10 Finalising a configuration

1. Make additional changes to the configuration as required.
2. Once all tiers are configured as desired, click on **Finalise**.
→ The **Finalise** window appears.

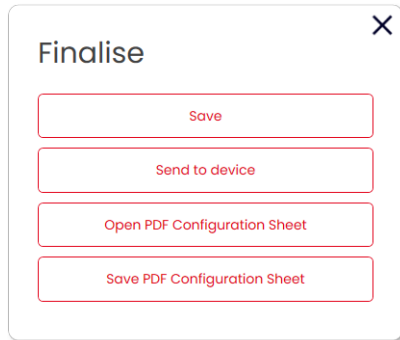

3. Click on **Save** to save the configuration in a configuration file.
4. Click on **Send to device** to transfer the configuration to the connected eSIGN.
5. Click on **Open PDF Configuration Sheet** to display an overview of the current configuration.
6. Click on **Save PDF Configuration Sheet** to save the overview of the current configuration as a PDF file.

4.5.3 Filling level mode



The eSIGN segments are used as a filling level indicator in this operating mode. This enables precise signalisation of the job progress or material availability in machine processes by slowly illuminating the signal tower from bottom to top or top to bottom.

Mode: Filling Level ✕

Device

eSIGN 15 Segments with Siren

Colours

Single Colour

Number of signal combinations: 15

=====

= Number of assigned segments: 15
= Number of unassigned segments: 0

Allocation of unassigned segments

Top (filled)

Generate Configuration

4.5.3.1 Selecting a eSIGN variant

The variant is pre-selected accordingly if an eSIGN has been connected. If no eSIGN has been connected, the variant of the eSIGN to be configured can be selected.

1. If necessary, select the variant of the eSIGN in the **Device** field.

Device

eSIGN 15 Segments with Siren

eSIGN 15 Segments with Siren

eSIGN 15 Segments

eSIGN 9 Segments with Siren

eSIGN 9 Segments

4.5.3.2 Selecting the number of signal combinations

1. Select in the **Number of signal combinations** area how many eSIGN segments are to be used for the filling level indicator.

If not all eSIGN segments are used for the filling level indicator:

2. Select in the **Allocation of unassigned segments** field how to display the eSIGN segments that are not to be used for the filling level indicator.

Setting	Description
Top (filled)	Unassigned eSIGN segments are assigned to the top and triggered with the top tier.
Bottom (filled)	Unassigned eSIGN segments are assigned to the bottom and triggered with the bottom tier.
Top (not active)	Unassigned eSIGN segments are assigned to the top and are always off.
Bottom (not active)	Unassigned eSIGN segments are assigned to the bottom and are always off.

4.5.3.3 Selecting a colour

A uniform colour or colour gradient can be selected for the filling level indicator. The colour gradient option means that the gradual transformation between the two colours is automatically calculated.

If necessary, the colour of each segment of the filling level indicator can be adjusted later.

1. Select whether the filling level should be displayed in a uniform colour or as a colour gradient in the **Colours** field.

Single colour

1. Click on the colour field to select the desired colour.
→ The **Select colour** window appears.

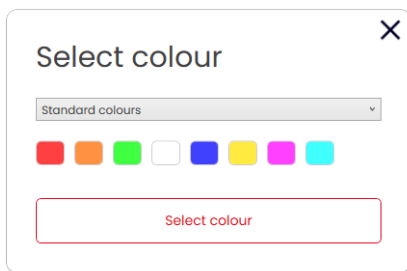

2. Select whether to use a standard colour or an individual colour.

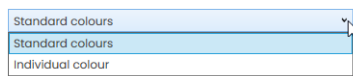

Standard colour

1. Click on the desired colour field.



The following 8 standard colours are available:

- red
- yellow
- green
- white
- blue
- light yellow
- violet
- turquoise

Individual colour

1. Select the desired colour in the colour field or enter the appropriate RGB value in the **Red**, **Green** and **Blue** fields.

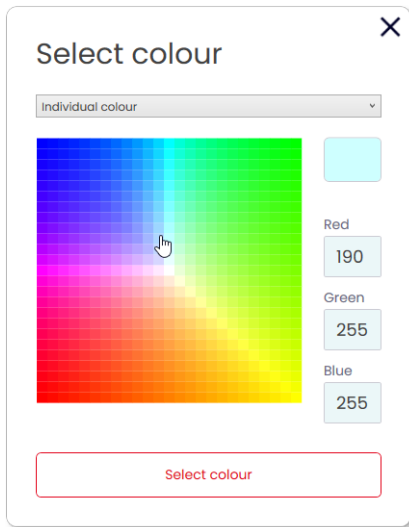

2. Click on **Select colour**.

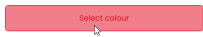

3. Click on **Generate Configuration**.
→ The **Configuration** screen appears.

Colour gradient

1. Click on the colour fields for the start and end colour of the colour gradient.
→ The **Select colour** window appears.

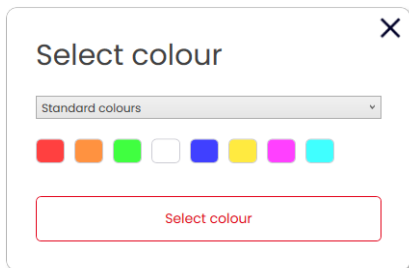

2. Select whether to use a standard colour or an individual colour.

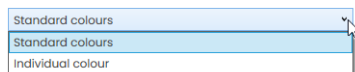

Standard colour

1. Click on the desired colour field.



Individual colour

1. Select the desired colour in the colour field or enter the appropriate RGB value in the **Red**, **Green** and **Blue** fields.

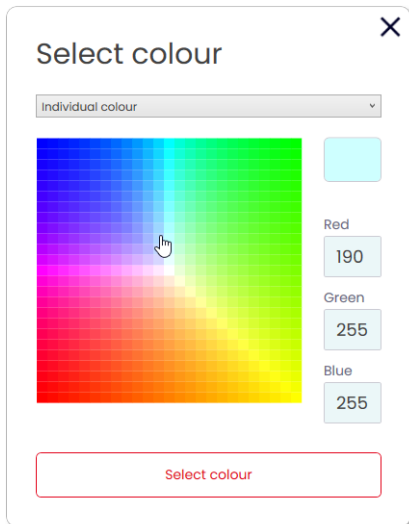

2. Click on **Select colour**.

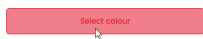

3. Click on **Generate Configuration**.
→ The **Configuration** screen appears.

4.5.3.4 Configuring the filling level indicator

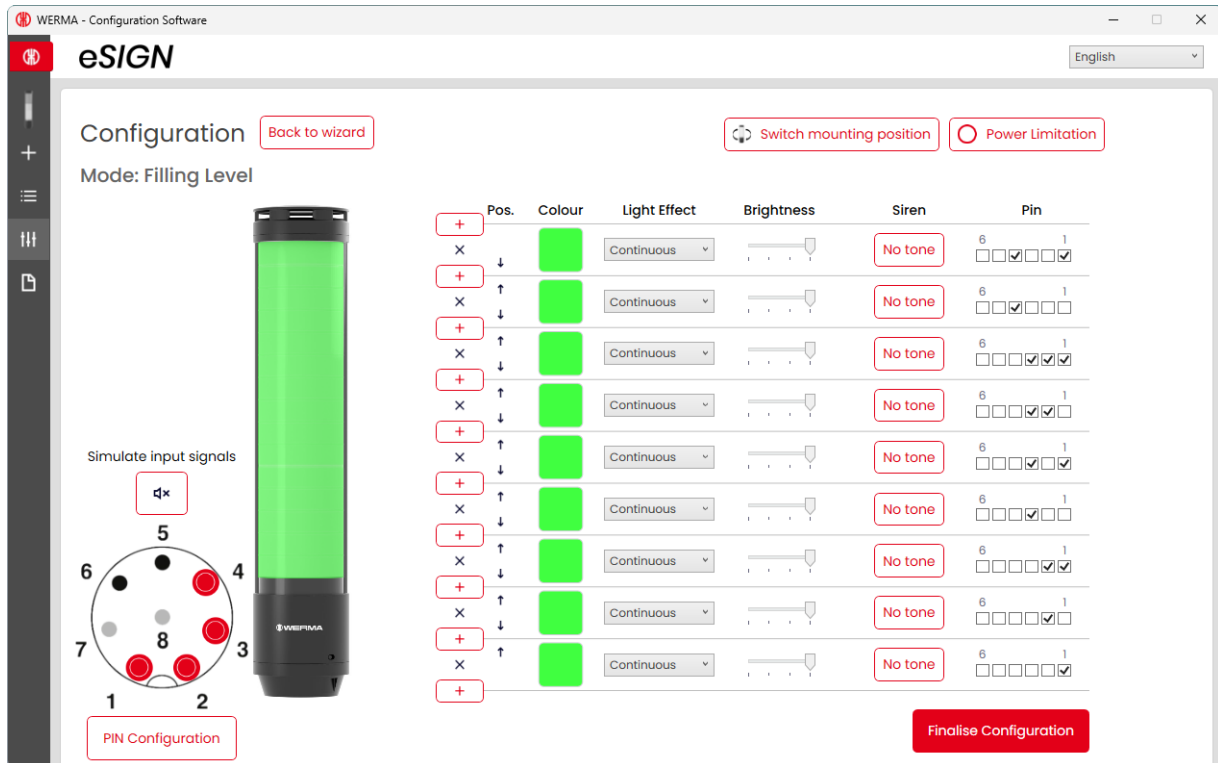

i If necessary, the orientation of the displayed signal tower can be rotated by 180° with the **Switch mounting position** button.

i If necessary (for example, to take into account the power limits of control outputs), the power consumption of the eSIGN can be reduced with the **Power Limitation** button. In this case, the current power requirement of the tower is reduced to less than 500 mA. As a result, the optical signals' brightness or the audible signals' volume is reduced.

i If necessary, the configuration of the colour and segments can be opened and adjusted via the **Back to wizard** link.

Removing or adding segments

Removing a segment

1. Click on **Delete**.



→ The segment has been removed.

Adding a segment

1. Click on **Add**.



→ The segment has been added.

Moving a segment

The individual segments can be moved up or down as required.





1. Click on the Move up or Move down arrow in the **Pos.** column to move the segment up or down.

	Pos.	Colour	Light Effect	Brightness	Siren	Pin					
x	↓	■	Continuai ▾		No tone	6	<input type="checkbox"/>	<input checked="" type="checkbox"/>	<input checked="" type="checkbox"/>	<input checked="" type="checkbox"/>	<input checked="" type="checkbox"/>
x	↑	■	Continuai ▾		No tone	6	<input type="checkbox"/>	<input checked="" type="checkbox"/>	<input checked="" type="checkbox"/>	<input checked="" type="checkbox"/>	<input type="checkbox"/>

Selecting a colour

A standard colour can be selected for each segment or an individual colour assigned as required.

1. Click on the colour field in the **Colour** column.

Pos.	Colour	Light Effect	Brightness	Siren	Pin
x		Continual		No tone	6 <input type="checkbox"/> <input checked="" type="checkbox"/> <input checked="" type="checkbox"/> <input checked="" type="checkbox"/> 1
x		Continual		No tone	6 <input type="checkbox"/> <input checked="" type="checkbox"/> <input checked="" type="checkbox"/> <input checked="" type="checkbox"/> 1

→ The **Select colour** window appears.

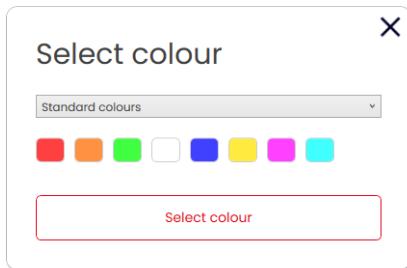

2. Select whether to use a standard colour or an individual colour.

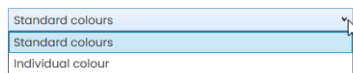

Standard colour

1. Click on the desired colour field.



The following 8 standard colours are available:

- red
- yellow
- green
- white
- blue
- light yellow
- violet
- turquoise

Individual colour

1. Select the desired colour in the colour field or enter the appropriate RGB value in the **Red**, **Green** and **Blue** fields.

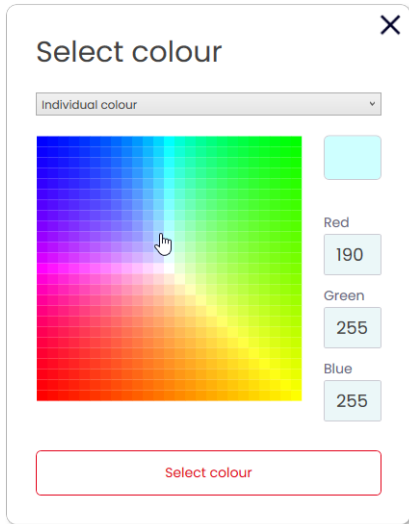

2. Click on **Select colour**.

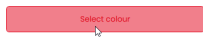

Selecting a light pattern

1. Select the desired light pattern in the **Light Effect** column.

Pos.	Colour	Light Effect	Brightness	Siren	Pin
x	↓	Continuous		No tone	6 <input type="checkbox"/> <input type="checkbox"/> <input checked="" type="checkbox"/> <input checked="" type="checkbox"/>
x	↓	Continuous		No tone	6 <input type="checkbox"/> <input type="checkbox"/> <input checked="" type="checkbox"/> <input checked="" type="checkbox"/>
x	↓	Blink: 1Hz		No tone	6 <input type="checkbox"/> <input type="checkbox"/> <input checked="" type="checkbox"/> <input checked="" type="checkbox"/>
x	↓	Blink: 2Hz		No tone	6 <input type="checkbox"/> <input type="checkbox"/> <input checked="" type="checkbox"/> <input checked="" type="checkbox"/>
x	↓	Blink: 3Hz		No tone	6 <input type="checkbox"/> <input type="checkbox"/> <input checked="" type="checkbox"/> <input checked="" type="checkbox"/>
x	↓	Flash: 1x		No tone	6 <input type="checkbox"/> <input type="checkbox"/> <input checked="" type="checkbox"/> <input checked="" type="checkbox"/>
x	↓	Flash: 2x		No tone	6 <input type="checkbox"/> <input type="checkbox"/> <input checked="" type="checkbox"/> <input checked="" type="checkbox"/>
x	↓	Flash: 3x		No tone	6 <input type="checkbox"/> <input type="checkbox"/> <input checked="" type="checkbox"/> <input checked="" type="checkbox"/>
x	↓	Rotating		No tone	6 <input type="checkbox"/> <input type="checkbox"/> <input checked="" type="checkbox"/> <input checked="" type="checkbox"/>
x	↓	None		No tone	6 <input type="checkbox"/> <input type="checkbox"/> <input checked="" type="checkbox"/> <input checked="" type="checkbox"/>

The following 8 light effects are available:

- Continuous light
- Blinking 1 Hz
- Blinking 2 Hz
- Blinking 3 Hz
- Flashing 1x
- Flashing 2x
- Flashing 3x
- Rotating
- None



The setting **None** can be selected if the tier is only to be configured with a siren.

Setting the brightness

1. Set the desired brightness of the tier from the 4 options in the **Brightness** column.

Pos.	Colour	Light Effect	Brightness	Siren	Pin
x	↓	Green	Continuoi	No tone	6 1 <input type="checkbox"/> <input type="checkbox"/> <input checked="" type="checkbox"/> <input checked="" type="checkbox"/> <input checked="" type="checkbox"/> <input checked="" type="checkbox"/>
x	↑	Green	Continuoi	No tone	6 1 <input type="checkbox"/> <input type="checkbox"/> <input checked="" type="checkbox"/> <input checked="" type="checkbox"/> <input checked="" type="checkbox"/> <input type="checkbox"/>

Selecting a siren

If the connected or selected eSIGN has a siren, you can select a signal tone which will sound when the segment is enabled.

i If several tiers are set, and the tiers are enabled at the same time, the siren will sound for the colour with the highest priority (highest position within the tower).

1. Click on **No tone** in the **Siren** column.

Pos.	Colour	Light Effect	Brightness	Siren	Pin
x	↓	Green	Continuoi	No tone	6 1 <input type="checkbox"/> <input type="checkbox"/> <input checked="" type="checkbox"/> <input checked="" type="checkbox"/> <input checked="" type="checkbox"/> <input checked="" type="checkbox"/>
x	↑	Green	Continuoi	No tone	6 1 <input type="checkbox"/> <input type="checkbox"/> <input checked="" type="checkbox"/> <input checked="" type="checkbox"/> <input checked="" type="checkbox"/> <input type="checkbox"/>

→ The **Select tone** window appears.

×

Select tone

Tone: No tone

Volume:



Max. Duration:



as long as signal active

▶
Select tone

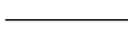
2. Select the desired **Tone**, the desired **Volume** and **Max. Duration**.

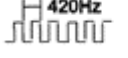
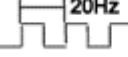
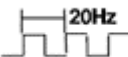
The following 10 tones are available:

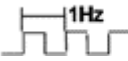
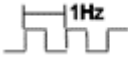
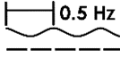
Sound	Frequency	Description	Max. dB (A)
1	 2.7 kHz	Continuous tone	104
2	 0.9 kHz	Continuous tone	96
3	 2.8 kHz	Pulse tone	97
4	 0.9 kHz	Pulse tone	93
5	 2.8 kHz	Pulse tone	103

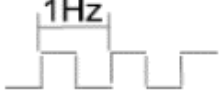
Sound	Frequency	Description	Max. dB (A)
6	 0.9 kHz	Pulse tone	96
7	 2.8 kHz	Pulse tone	104
8	 2.3 kHz- 3.6 kHz	Sweep tone	104
9	 2.6 kHz	Continuous tone	105
10	 1200 Hz 800 Hz	Alternating tone	92

i The selected sound can be tested with button ▶ in the selection of tones. The sound is then played by the computer.

3. Click on **Select tone**.

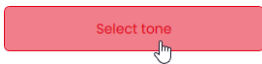

Selecting a pin

- i** The fields are pre-configured with a standard configuration, starting from the bottom tier of the tower with pin 1. Pins that are already in use are shown in grey. The configuration can be changed as required.

The filling level indicator is triggered via bit coding. The checkboxes in the **Pin** column correspond to the 6 pins or signal inputs. Selecting one or more checkboxes indicates that these pins or signal inputs must be triggered to enable the corresponding setting.

Example:

For the complete tower to be displayed in green, pins 1-4 must be triggered.

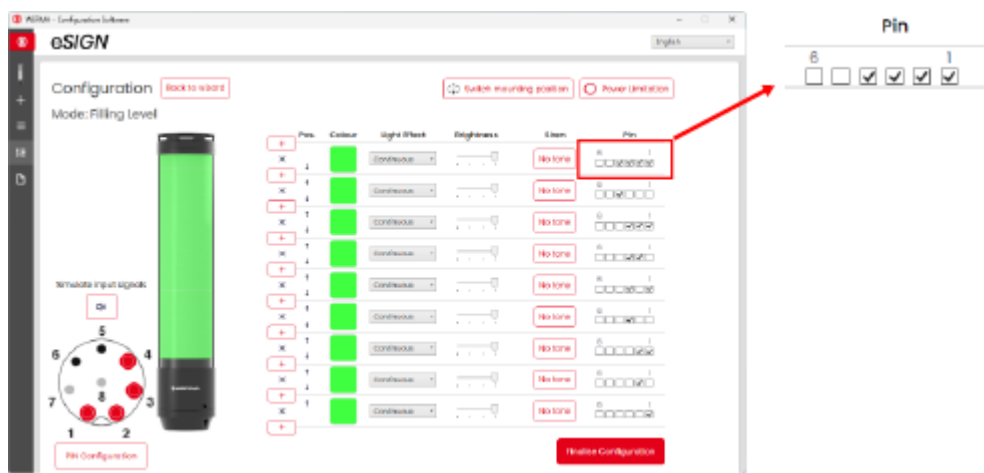

- Select the pins of the 8-pin connector on which the signal to trigger the tier is sent in the **Pin** column.

Pos.	Colour	Light Effect	Brightness	Siren	Pin					
X ↓	Green	Continual	[Slider]	No tone	6	5	4	3	2	1
X ↑	Green	Continual	[Slider]	No tone	6	5	4	3	2	1

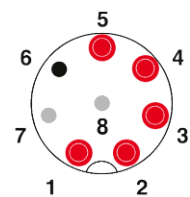

Modifying a pin configuration

If necessary, the assignment of the wire colour to the pin can be changed and a description of the signal added.

1. Click on **PIN Configuration** under the pin overview.

PIN Configuration

→ The **PIN Configuration** window appears.

PIN Configuration

	Wire Colour	Description
Pin 1: Input 1	WH	
Pin 2: Input 2	BN	
Pin 3: Input 3	GN	
Pin 4: Input 4	YE	
Pin 5: Input 5	GY	
Pin 6: Input 6	PK	
Pin 7: COM	BU	
Pin 8: +24V	RD	

Save

2. Enter the desired wire colour in the **Colour** column.
3. Enter the description of the signal in the **Description** column.
4. Click on **Save**.

4.5.3.5 Simulating signal inputs

Once all settings have been made, the signal inputs can be simulated.

1. Click on the pin that enables the desired tier in the pin overview.

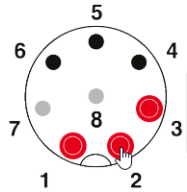

4.5.3.6 Finalising a configuration

1. Make additional changes to the configuration as required.
2. Once all tiers are configured as desired, click on **Finalise**.
→ The **Finalise** window appears.

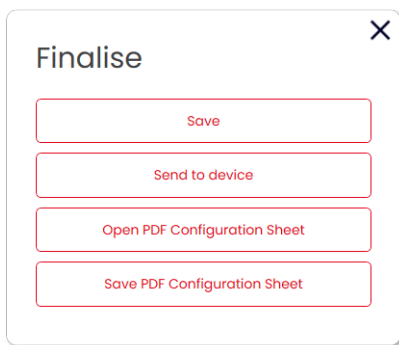

3. Click on **Save** to save the configuration in a configuration file.
4. Click on **Send to device** to transfer the configuration to the connected eSIGN.
5. Click on **Open PDF Configuration Sheet** to display an overview of the current configuration.
6. Click on **Save PDF Configuration Sheet** to save the overview of the current configuration as a PDF file.

4.5.4 Individual mode



A free combination of individual segment settings is mapped to a certain switching signal in this operating mode. Every eSIGN segment can be individually set and triggered as a complete signal pattern in the form of the entire signal tower. The **Individual** mode enables a maximum of individual signalling options in this way.

4.5.4.1 Selecting a eSIGN variant

The variant is pre-selected accordingly if an *SIGNe* has been connected. If no eSIGN has been connected, the variant of the eSIGN to be configured can be selected.

1. If necessary, select the variant of the eSIGN in the **Device** field.

Device

2. Click on **Generate Configuration**.
→ The **Configuration** screen appears.

4.5.4.2 Configuring signal patterns

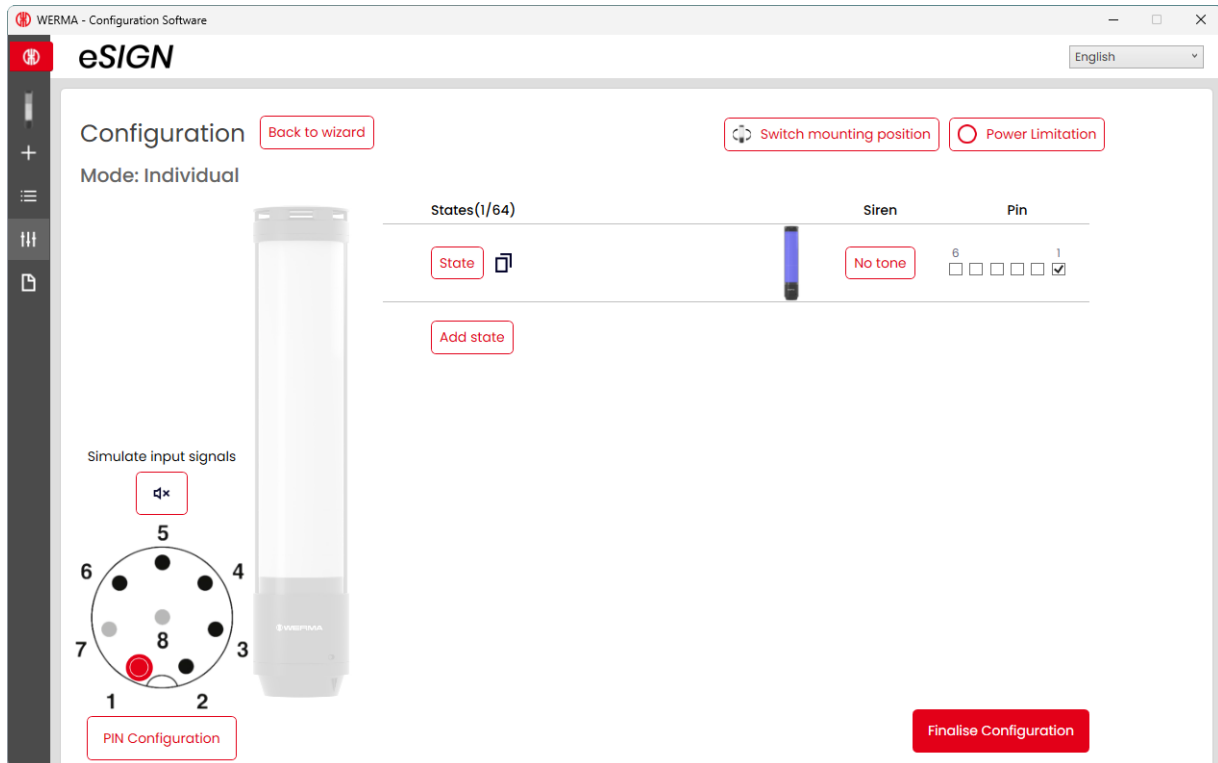

i If necessary, the orientation of the displayed signal tower can be rotated by 180° with the **Switch mounting position** button.

i If necessary (for example, to take into account the power limits of control outputs), the power consumption of the eSIGN can be reduced with the **Power Limitation** button. In this case, the current power requirement of the tower is reduced to less than 500 mA. As a result, the optical signals' brightness or the audible signals' volume is reduced.

i The configuration of the eSIGN variant can be opened and adjusted again via the **Back to wizard** link as required.

Modifying a signal pattern



Up to 64 signal patterns can be configured and transferred to an eSIGN.

A signal pattern consists of the individual optical settings of each segment and, if relevant, a signal tone.

1. Click on **State**.

States(1/64)



→ The **State** window appears.

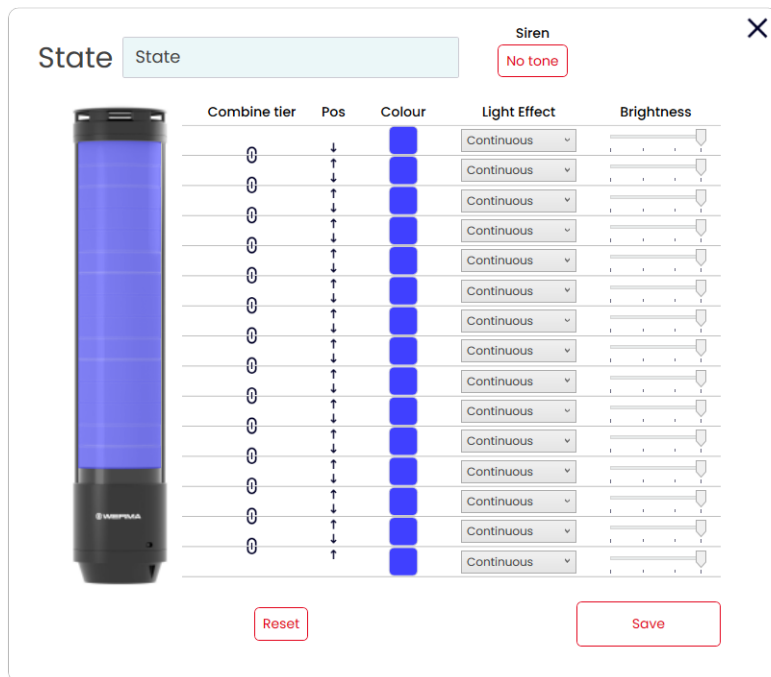

If necessary, the current signal pattern can be reset to the default settings via the **Reset** button.

Naming a signal pattern

1. Enter a description for the current signal pattern in the **State** field.

Selecting a siren

If the connected or selected eSIGN has a siren, you can select a signal tone which will sound when the signal pattern is enabled.

1. Click on **No tone** in the **Siren** field.

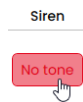

→ The **Select tone** window appears.

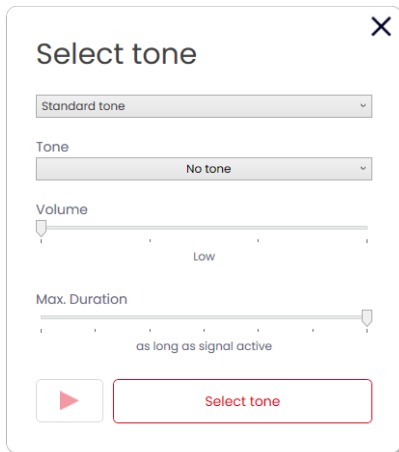



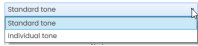

2. Select whether to use a standard tone or an individual tone.



Standard tone

3. Select the desired **Tone** , the desired **Volume** and **Max. Duration**.

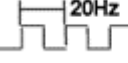
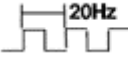
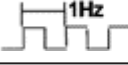
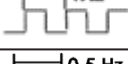
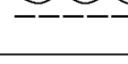
The following 10 tones are available:

Sound	Frequency	Description	Max. dB (A)
1	 2.7 kHz	Continuous tone	104
2	 0.9 kHz	Continuous tone	96
3	 2.8 kHz	Pulse tone	97
4	 0.9 kHz	Pulse tone	93
5	 2.8 kHz	Pulse tone	103
6	 0.9 kHz	Pulse tone	96
7	 2.8 kHz	Pulse tone	104
8	 2.3 kHz- 3.6 kHz	Sweep tone	104
9	 2.6 kHz	Continuous tone	105
10	 1200 Hz 800 Hz	Alternating tone	92

 The selected sound can be tested with button ▶ in the selection of tones. The sound is then played by the computer.

4. Click on **Select tone**.

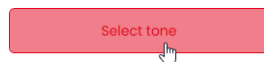

Individual tone

Select tone
✕

Individual tone

Graphical Parameter Description

Volume

Low

Tone type

Permanent

Hold time Frequency 2 (ms) ?

0

Frequency 1 (Hz) ?

1000

Repeat count ?

0

Pause after repeat (ms) ?

0

Pause between cycles (ms) ?

0

Select tone

1. Make the settings as desired.



The **Individual tone** option allows a customer-specific tone to be generated from different parameters.

Further information on the individual settings can be accessed via the **Graphical Parameter Description** button and by clicking on **?**.

The following screen can be accessed via the **Graphical Parameter Description** button to illustrate the effect of the individual settings.

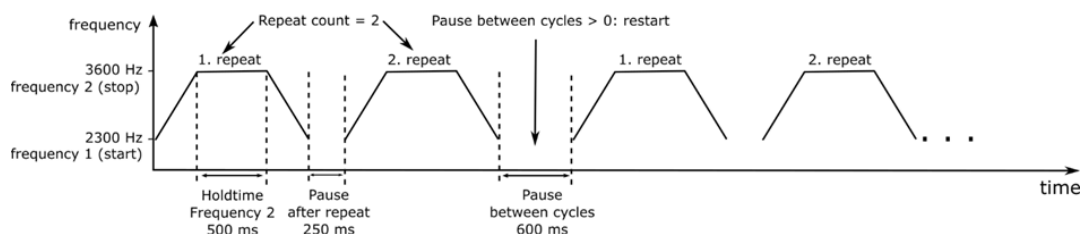

2. Click on **Select tone**.

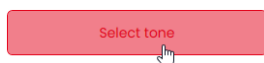

Connecting or separating segments

If required, multiple segments can be connected to form a tier and then separated again.

Connecting segments

1. Click on the **Stufen verbinden** symbol in the **Stufen verbinden** column.



Separating segments

1. Click on the **Stufen trennen** symbol in the **Stufen verbinden** column.



Moving tiers

The individual tiers can be moved up or down as required.

1. Click on the Move up or Move down arrow in the **Pos.** column to move the tier up or down.

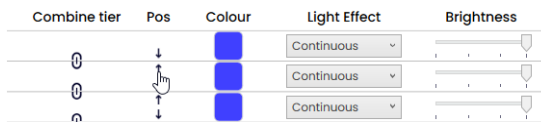

Selecting a colour

A standard colour can be selected for each segment or an individual colour assigned as required.

1. Click on the colour field in the **Colour** column.



→ The **Select colour** window appears.

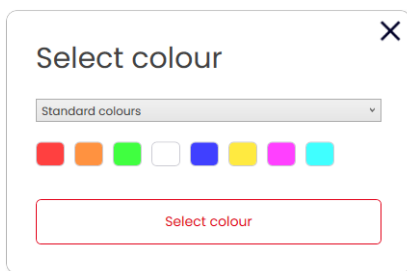

2. Select whether to use a standard colour or an individual colour.

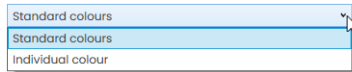

Standard colour

1. Click on the desired colour field.



The following 8 standard colours are available:

- red
- yellow
- green
- white
- blue
- light yellow
- violet
- turquoise

Individual colour

1. Select the desired colour in the colour field or enter the appropriate RGB value in the **Red**, **Green** and **Blue** fields.

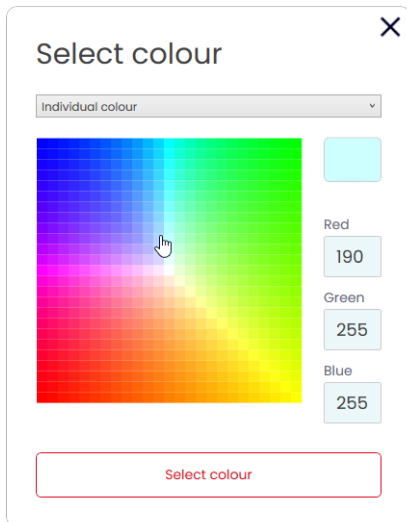

2. Click on **Select colour**.

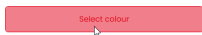

Selecting a light pattern

1. Select the desired light pattern in the **Light Effect** column.

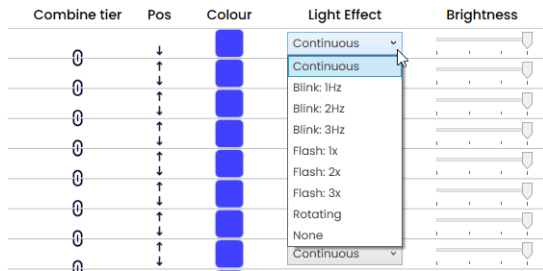

The following 8 light effects are available:

- Continuous light
- Blinking 1 Hz
- Blinking 2 Hz
- Blinking 3 Hz
- Flashing 1x
- Flashing 2x
- Flashing 3x
- Rotating
- None

Setting the brightness

1. Set the desired brightness of the tier from the 4 options in the **Brightness** column.

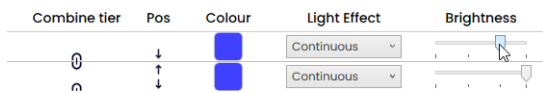

As soon as all settings have been made:

2. Click on **Save**.



4.5.4.3 Selecting a pin

-  The fields are pre-configured with a standard configuration.
The configuration can be changed as required.

The individual signal effects are triggered via bit coding. The checkboxes in the **Pin** column correspond to the 6 pins or signal inputs. Selecting one or more checkboxes indicates that these pins or signal inputs must be triggered to enable the corresponding signal pattern.

Example:

Pins 1-4 must be triggered to enable the second signal pattern.

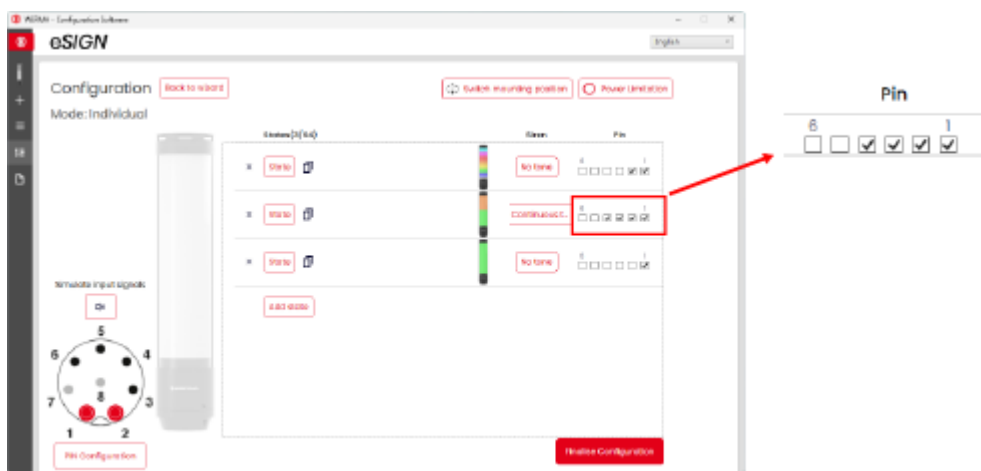

- Select the pins of the 8-pin connector on which the signal to trigger the signal pattern is sent in the **Pin** column.

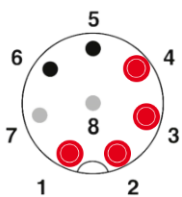
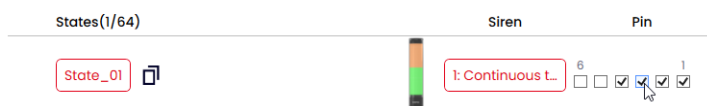

Modifying a pin configuration

If necessary, the assignment of the wire colour to the pin can be changed and a description of the signal added.

1. Click on **PIN Configuration** under the pin overview.



→ The **PIN Configuration** window appears.

PIN Configuration
✕

	Wire Colour	Description
Pin 1: Input 1	WH	
Pin 2: Input 2	BN	
Pin 3: Input 3	GN	
Pin 4: Input 4	YE	
Pin 5: Input 5	GY	
Pin 6: Input 6	PK	
Pin 7: COM	BU	
Pin 8: +24V	RD	

2. Enter the desired wire colour in the **Colour** column.
3. Enter the description of the signal in the **Description** column.
4. Click on **Save**.

4.5.4.4 Duplicating a signal pattern



Up to 64 signal patterns can be configured and transferred to an eSIGN.

A signal pattern consists of the individual optical settings of each segment and, if relevant, a signal tone.

1. Click on **Duplicate** in the line of the desired signal pattern.



2. Configure the signal pattern as described.

4.5.4.5 Adding a signal pattern



Up to 64 signal patterns can be configured and transferred to an eSIGN.

A signal pattern consists of the individual optical settings of each segment and, if relevant, a signal tone.

1. Click on **Add state**.



2. Configure the signal pattern as described.

4.5.4.6 Deleting a signal pattern

1. Click on **Delete** in the line of the desired signal pattern.



4.5.4.7 Simulating signal inputs

Once all settings have been made, the signal inputs can be simulated.

1. Click on the pin that enables the desired signal effect in the pin overview.

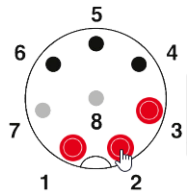

4.5.4.8 Finalising a configuration

1. Make additional changes to the configuration as required.
2. Once all signal effects are configured as desired, click on **Finalise**.
→ The **Finalise** window appears.

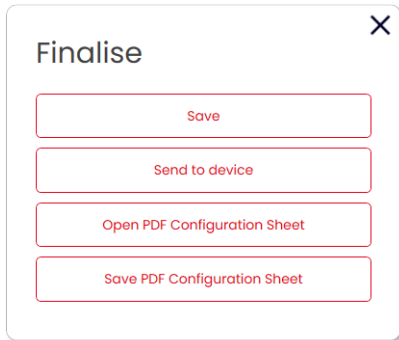

3. Click on **Save** to save the configuration in a configuration file.
4. Click on **Send to device** to transfer the configuration to the connected eSIGN.
5. Click on **Open PDF Configuration Sheet** to display an overview of the current configuration.
6. Click on **Save PDF Configuration Sheet** to save the overview of the current configuration as a PDF file.

4.6 Creating a configuration from sample templates

The WERMA - Configuration Software provides several predefined configurations that can be transferred directly to a connected eSIGN or used as a basis for your own configurations.

1. Click on **Create from templates** in the **Configuration** area.

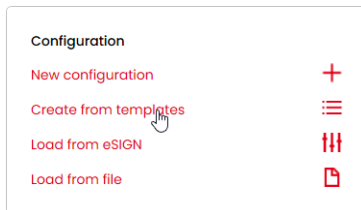

→ The **Create new configuration from templates** window appears.

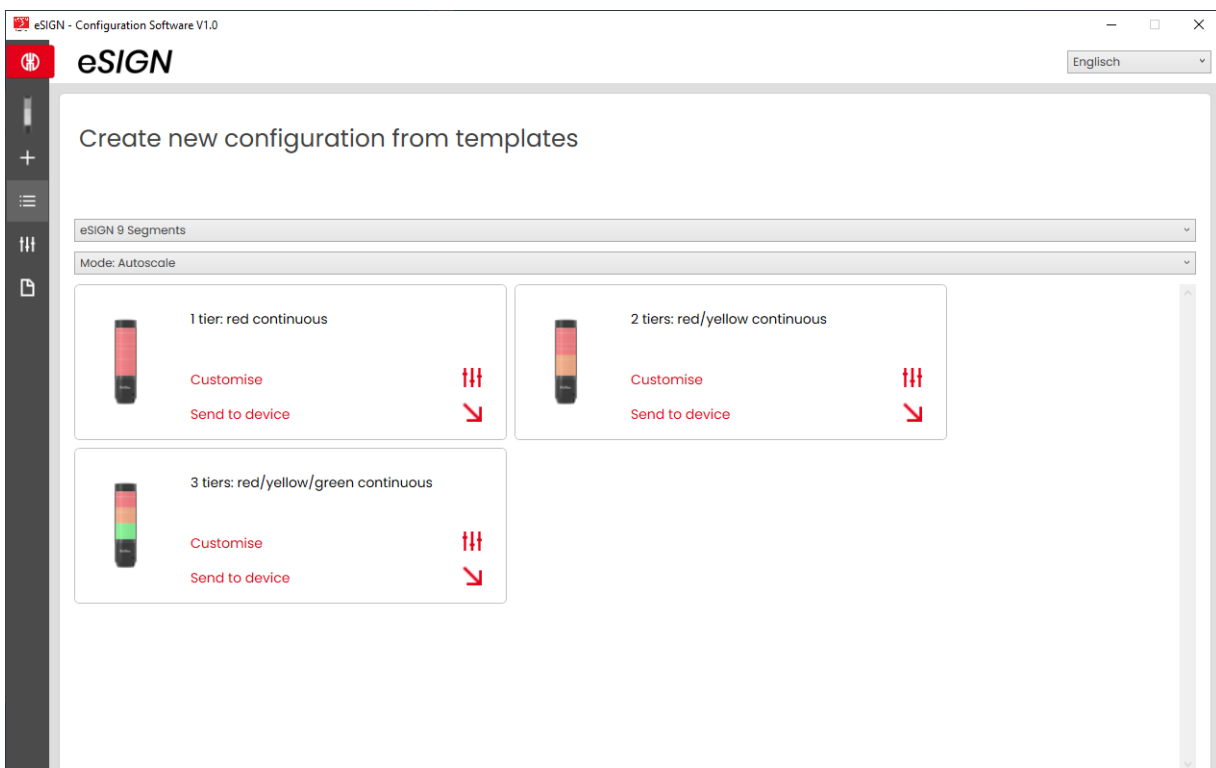

2. Select the eSIGN variant.
3. Select the mode.
→ The available templates are displayed.
4. Click on **Customise** in the desired template to load and continue editing the template.
5. Click on **Send to device** to load the template and transfer it directly to the connected eSIGN.



For more information on the configuration, see "Creating a new configuration", S. 104.

4.7 Loading the configuration of the connected eSIGN

If an eSIGN is connected to the computer, the WERMA - Configuration Software offers the option of opening the current configuration (for example the default setting) for editing. If no eSIGN is connected, this menu item is faded out.

1. Click on **Load from eSIGN** in the **Configuration** area.

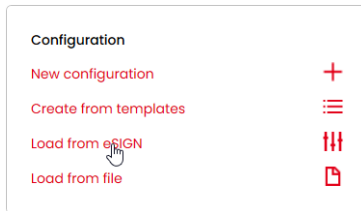

→ The **Configuration** window appears in the set mode and is already filled with the current configuration.



For more information on the configuration, see "Creating a new configuration", S. 104.

4.8 Opening an existing configuration

1. Click on **Load from file** in the **Configuration** area.

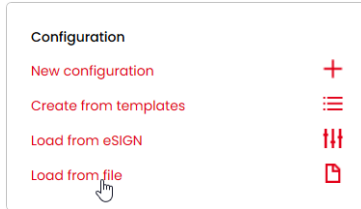

2. Select the desired configuration and click on **Open**.



Alternatively, the last used configurations can be displayed via the page menu (see "Overview", S. 102).

4.9 Updating the firmware



The computer must be connected to the Internet and an eSIGN to perform a firmware update.

1. Click on **Check if new Firmware available** in the **Firmware** area.

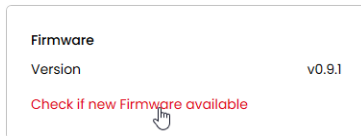

- The WERMA - Configuration Software checks for firmware updates for the connected eSIGN.
- A corresponding message appears if an update is found.

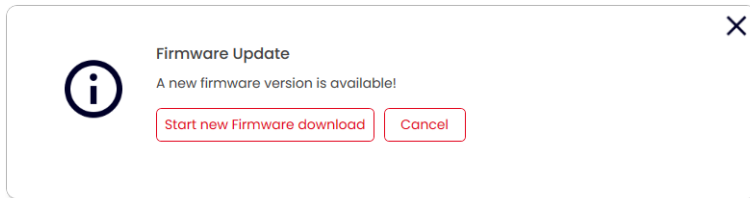

2. Click on **Start new Firmware download**.

- The new firmware is transferred to the connected eSIGN.

5 Configuring the MC55 Touch S

5.1 Function

The new MC55 Touch S turns a multi-coloured status light into an interactive interface for operators. With the intuitive configuration software, it is easy to realise multiple signalling modes with different colours, light images and sounds as well as time-controlled escalations.

From the simple acknowledgement of an acoustic alarm, to the transmission of a 24 V signal and the mapping of process cycles using time-controlled escalations, the MC55 Touch S offers a wide range of possible applications.

5.2 Hardware description

The hardware information applies to the following part numbers:

- 240.160.55 MC55 Touch S 24 VDC
- 240.170.55 MC55 Touch S 24 VDC Acoustic
- 240.260.55 MC55 Touch 24 VDC NPN
- 240.270.55 MC55 Touch 24 VDC NPN Acoustic
- 240.280.55 MC55 Touch 24 VDC PNP
- 240.290.55 MC55 Touch 24 VDC PNP Acoustic

5.2.1 Overview of the connection area

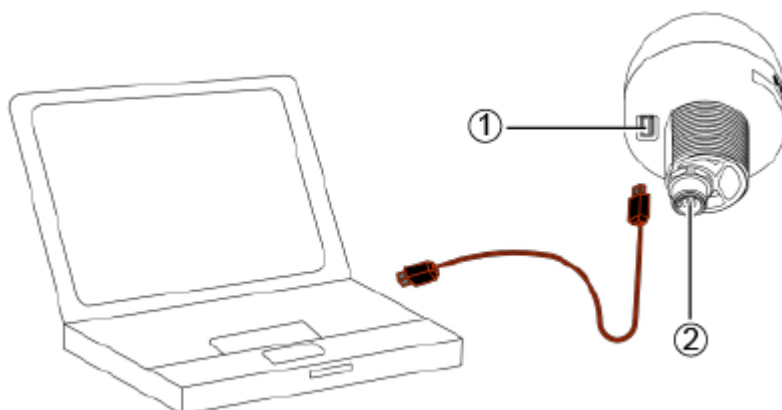

Item	Description
1	USB-C connection
2	5-pin M12 connector

5.2.2 Overview of the 5-pin M12 connector

The MC55 Touch S is connected via an 5-pin M12 connector with the following assignment:

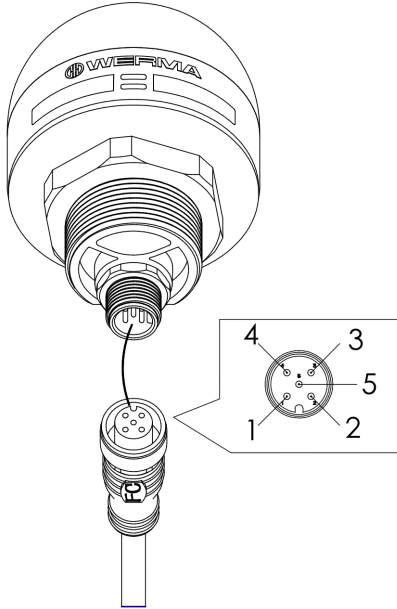

M12 pin assignment	Wire colour of M12 cable	Function
1	brown	Signal 1
2	white	Signal 2
3	blue	COM
4	black	Output 24 V; 200 mA
5	grey	Signal 3

5.2.3 Default setting

The MC55 Touch S is delivered as standard in Switch mode. When the touch input is enabled, 24 V is connected to the output.

5.3 Overview

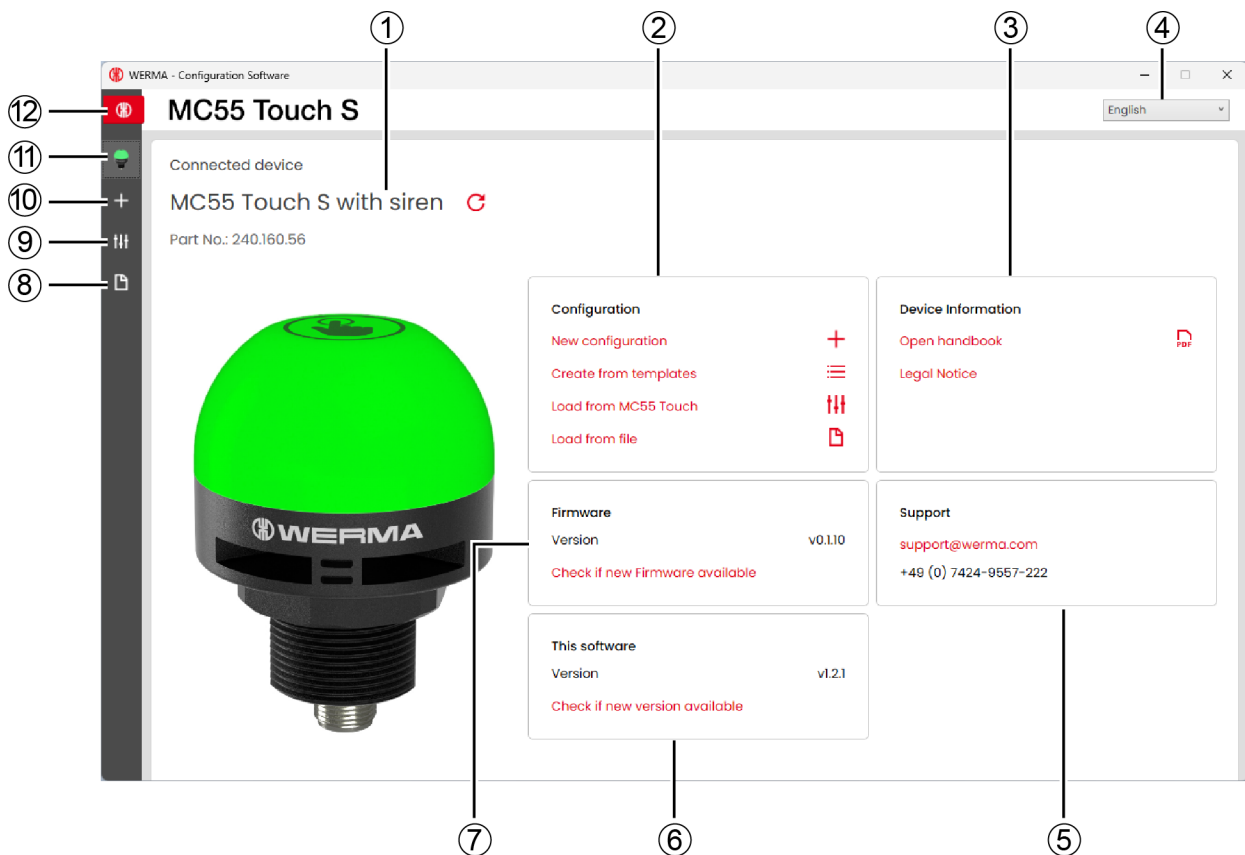

Item	Description
1	Variant of the connected MC55 Touch S
2	Configuration area
3	Device Information area
4	Setting the language
5	Support area
6	This software area
7	Firmware area
8	Opening an existing configuration
9	Loading a configuration from the MC55 Touch S
10	Creating a configuration from sample templates
11	Opening the start screen
12	Device selection

5.3.1 Configuration area

The following options for creating a configuration are available in the **Configuration** area:

- **New configuration:** Create a new configuration (see "Creating a new configuration", S. 161).
- **Create from templates:** Open standard templates that can be transferred to the device immediately (see "Creating a configuration from sample templates", S. 175).
- **Load from MC55 Touch:** Open the current configuration (for example the default setting) for editing (see "Loading the configuration of the connected MC55 Touch S", S. 177).
- **Load from file:** Open and reuse an existing configuration (see "Opening an existing configuration", S. 178).

5.3.2 Device Information area

The manual and legal information can be opened in the **Device Information** area.

5.3.3 Support area

The **Support** area displays the contact information of the WERMA support team.

5.3.4 This software area

The **This software** area displays information about the version status of the WERMA - Configuration Software and offers a possibility to update the configuration software.

5.3.5 Firmware area

The **Firmware** area displays information about the firmware of the connected MC55 Touch S and offers a possibility to update the firmware.

5.4 Setting the language

1. Select the desired language in the selection menu.

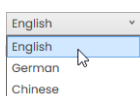

5.5 Creating a new configuration

i The configuration can be performed with or without a connected MC55 Touch S.

i The MC55 Touch S can be connected simultaneously to a computer via the USB cable and to the 24 V power supply via the M12 cable.

1. Use the USB cable to connect the MC55 Touch S to the computer.
→ The WERMA - Configuration Software detects the connected MC55 Touch S.

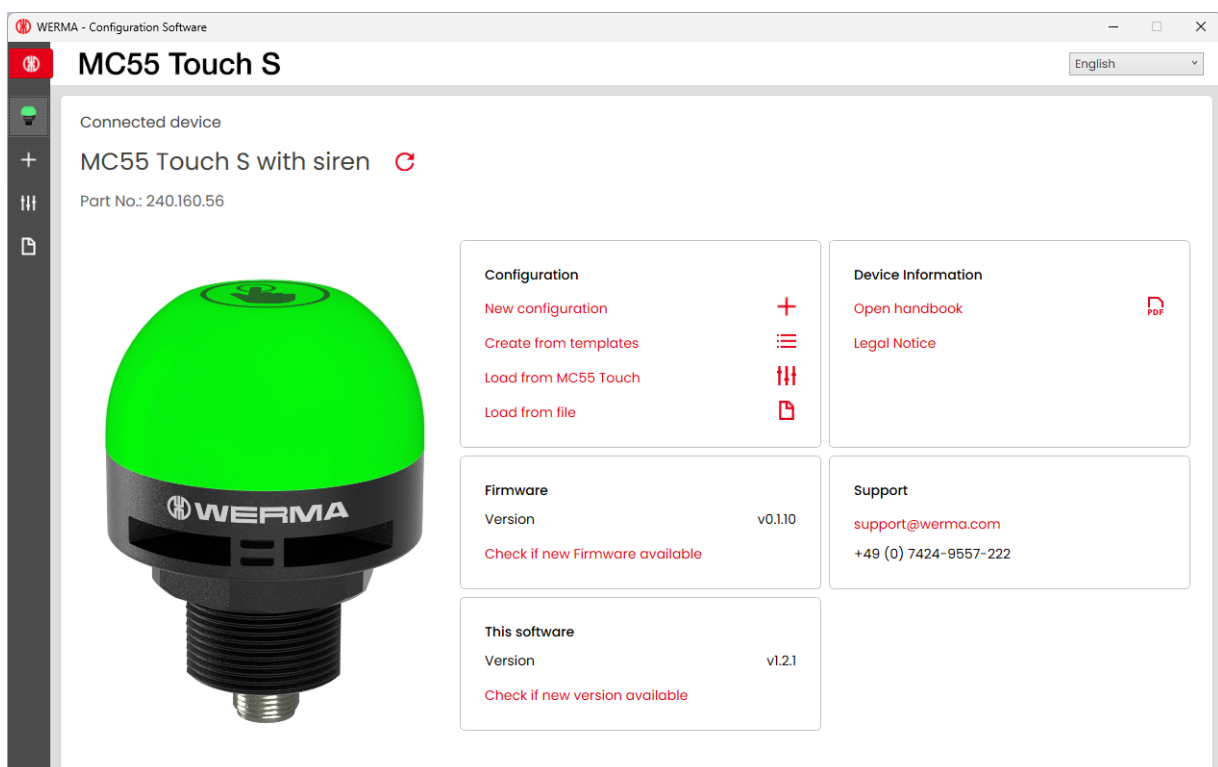

2. If the WERMA - Configuration Software does not detect the connected MC55 Touch S: Click on **Refresh connected device**.

No Device connected 

3. Click on **New configuration** in the **Configuration** area.

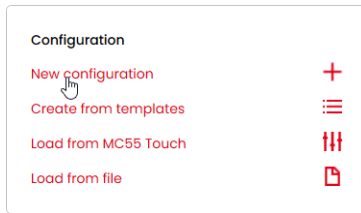

→ The **Configuration** screen appears.

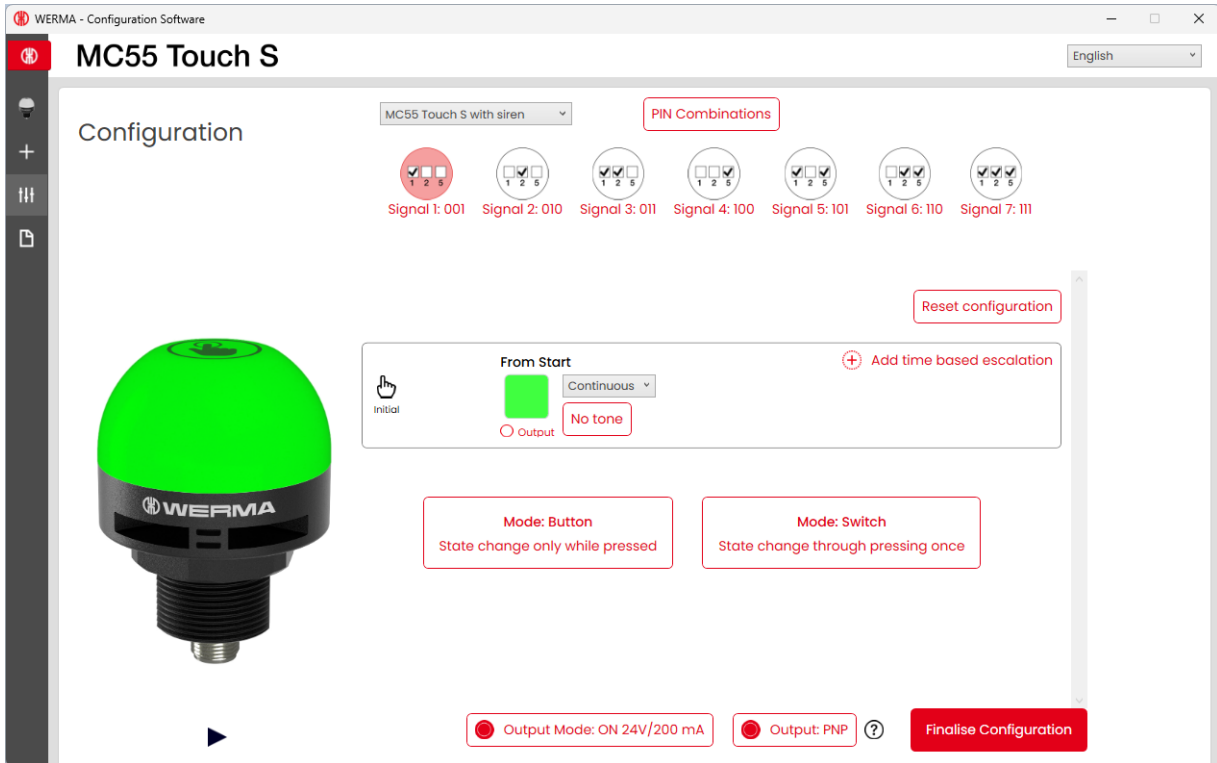

4. If necessary, select the variant of the MC55 Touch S to be configured.

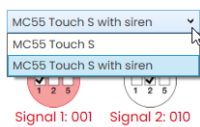

5. Select **Mode: Switch** or **Mode: Button**.

5.5.1 Selecting a signal input

Each signal input can be configured separately. The icons show the corresponding PIN assignment.

1. Click on the desired signal input.



5.5.1.1 Renaming a signal input

If necessary, the signal inputs can be renamed and supplemented with a description.

1. Click on **PIN Combinations** above the overview of the input signals.



→ The **PIN Combinations** window appears.

PIN Combinations

✕

	Shortname	Description
Signal 1: 001	<input type="text" value="Signal 1"/>	<input type="text"/>
Signal 2: 010	<input type="text" value="Signal 2"/>	<input type="text"/>
Signal 3: 011	<input type="text" value="Signal 3"/>	<input type="text"/>
Signal 4: 100	<input type="text" value="Signal 4"/>	<input type="text"/>
Signal 5: 101	<input type="text" value="Signal 5"/>	<input type="text"/>
Signal 6: 110	<input type="text" value="Signal 6"/>	<input type="text"/>
Signal 7: 111	<input type="text" value="Signal 7"/>	<input type="text"/>

2. Enter the desired description in the **Shortname** column.
3. Enter the description of the signal in the **Description** column.
4. Click on **Save**.

5.5.2 Changing the mode

The **Button** mode and **Switch** mode can be selected retrospectively for each signal input.

5.5.2.1 Mode Button

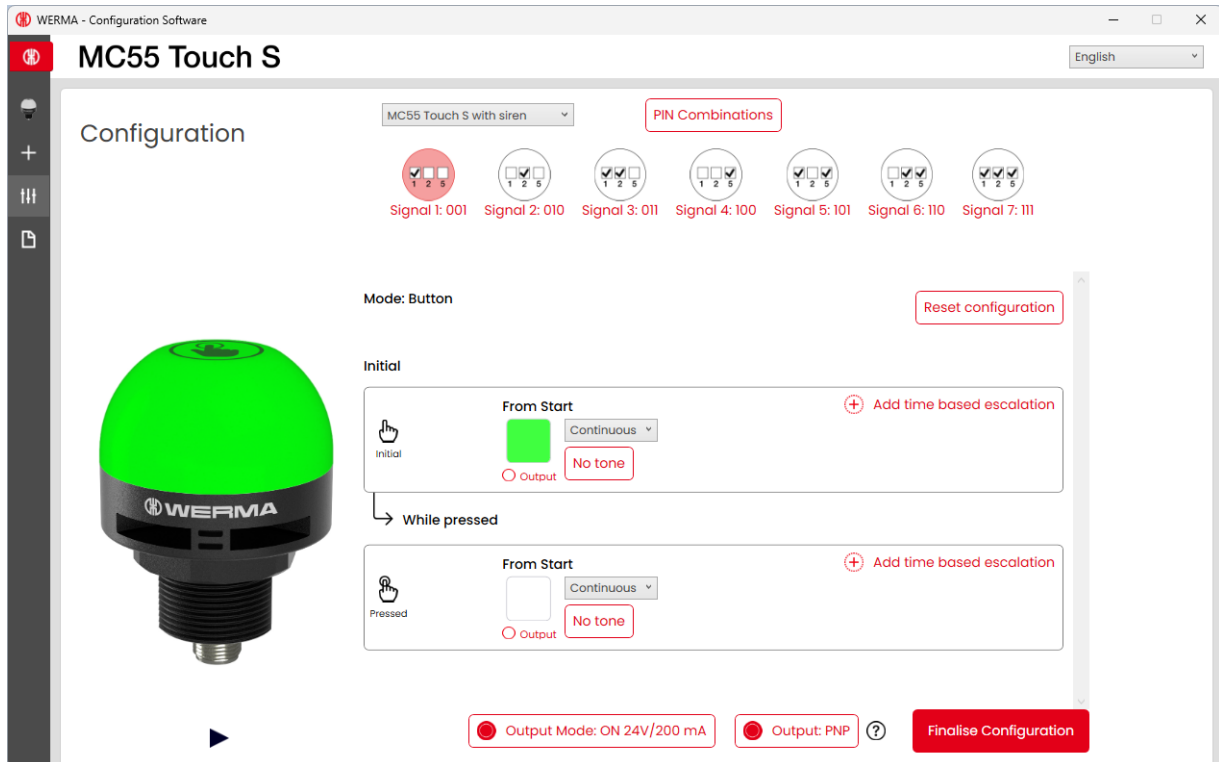

2 states can be configured in **Button** mode.

- Initial: Is active when current is present at the corresponding signal input and the MC55 Touch S is not pressed.
- Pressed: Is active when MC55 Touch S is pressed and kept pressed.
- As soon as the MC55 Touch S is no longer pressed, the initial state is active again.

For each state, the settings for the colour, the light pattern, the siren (if available), the time-based escalation and the output can be modified.

5.5.2.2 Mode Switch

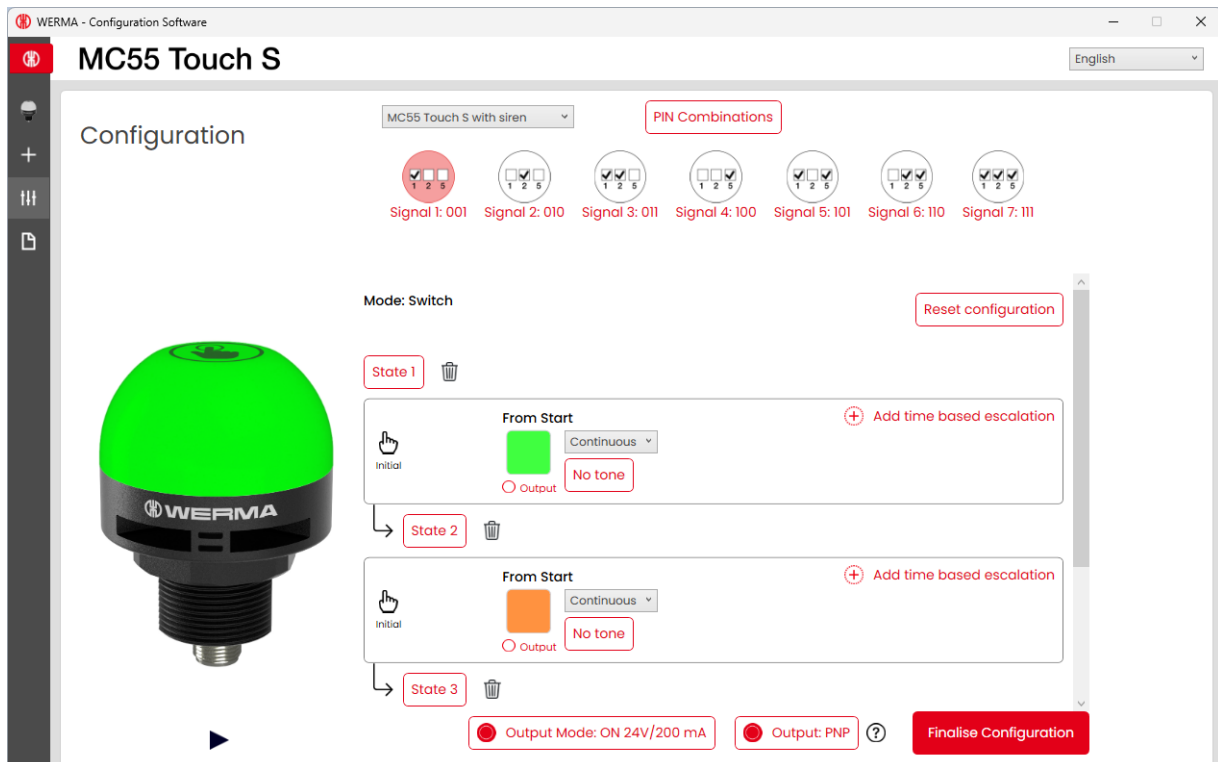

A maximum of 10 states can be configured in **Switch** mode. The next state is enabled each time you press the MC55 Touch S.

In **Switch** mode, the MC55 Touch S lights up white briefly when switching between states to provide feedback for detecting the touch input.

For each state, the settings for the colour, the light pattern, the siren (if available), the time-based escalation and the output can be modified.

i MC55 Touch S is delivered as standard in switch mode. When the touch input is enabled, 24 V is connected to the output.

1. Click on **Reset configuration** in the desired signal input.



2. Select **Mode: Button** or **Mode: Switch**.

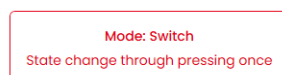
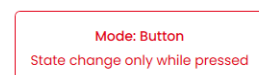

5.5.3 Modifying states

States can only be added, deleted or renamed in **Switch** mode. The two possible states are specified in **Button** mode.

5.5.3.1 Adding a state

1. Click on **Add state**.



5.5.3.2 Removing a state

1. Click on  next to the state to be removed (e.g. **State 3**).



5.5.3.3 Renaming a state

1. Click on the state (e.g. **State 1**).
→ The **State 1** window appears.

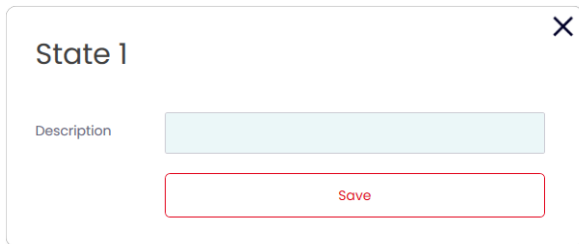

2. Enter the desired description of the state in the **Description** field.
3. Click on **Save**.

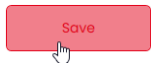

5.5.4 Selecting a colour

A standard colour or individual colour can be assigned to every tier.

1. Click on the colour field in the **Colour** column.

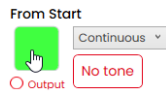

→ The **Select colour** window appears.

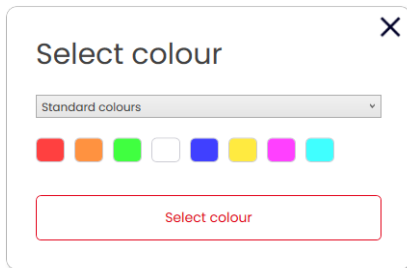

2. Select whether to use a standard colour or an individual colour.

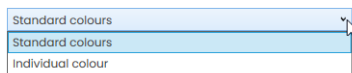

5.5.4.1 Standard colour

3. Click on the desired colour field.



The following 8 standard colours are available:

- red
- yellow
- green
- white
- blue
- light yellow
- violet
- turquoise

5.5.4.2 Individual colour

4. Select the desired colour in the colour field or enter the appropriate RGB value in the **Red**, **Green** and **Blue** fields.

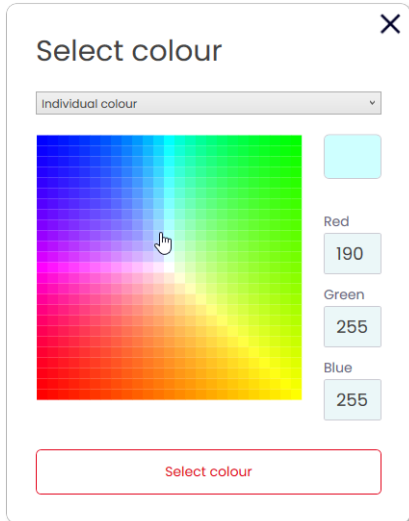

5. Click on **Select colour**.

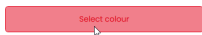

5.5.5 Selecting a light pattern

1. Click on the selection menu next to the colour field and select the desired light effect.

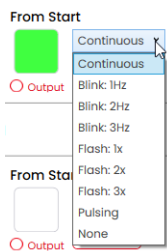

The following 8 light effects are available:

- Continuous light
- Blinking 1 Hz
- Blinking 2 Hz
- Blinking 3 Hz
- Flashing 1x
- Flashing 2x
- Flashing 3x
- Pulsing
- None

- i** The setting **None** can be selected if the pin assignment is to be used only for sound or for continuous power supply.

5.5.6 Selecting a siren

If the connected or selected MC55 Touch S has a siren, you can select a signal tone that will sound when the state is enabled.

1. Click on **No tone** in the desired state.

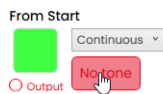



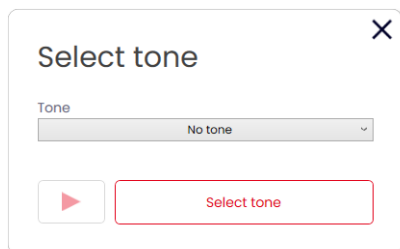





→ The **Select tone** window appears.

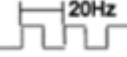

2. Select the desired **Tone**.

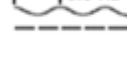
The following 10 tones are available:

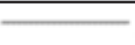
Sound	Frequency	Description	Max. dB (A)
1	 3.8 kHz	Continuous tone	86
2	 0.9 kHz	Continuous tone	70
3	 2.1 kHz	Pulse tone	67
4	 0.9 kHz	Pulse tone	68
5	 2.65 kHz	Pulse tone	66
6	 0.9 kHz	Pulse tone	70
7	 3.8 kHz	Pulse tone	87
8	 2.3 kHz - 3.6 kHz	Sweep tone	89

Sound	Frequency	Description	Max. dB (A)
9	 2.65 kHz	Continuous tone	67
10	 1.2 kHz - 0.8 kHz	Alternating tone	78

 The selected sound can be tested with button ▶ in the selection of tones. The sound is then played by the computer.

3. Click on **Select tone**.

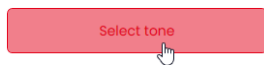

5.5.7 Modifying a time-based escalation

A maximum of two time-based escalations can be configured for each state in **Switch** mode or **Button** mode.

Once a time-based escalation has been configured, the next escalation is enabled after the set time has elapsed.

For each escalation, the time, the light image, the colour, the siren (if available) and the output can be configured.

5.5.7.1 Adding a time-based escalation

1. Click on **Add time based escalation**.



→ An escalation level has been added.



2. Click on **after 10 s**.

→ The **After 10 s** window appears.

After 10s
✕

Time to escalation (s)

10

Value: 0.1 to 3,600 seconds

Save

3. Enter the number of seconds after which the escalation level should start in the **Time to escalation (s)** field.

4. Click on **Save**.



5. Modify other properties (colour, light pattern, output, sound) of the escalation level as required.

6. If necessary, add another escalation level by clicking on .

5.5.7.2 Removing a time-based escalation

If necessary, the last escalation level can be removed.

1. Click on **Delete** in the last escalation level.



5.5.8 Enabling the output

The digital 24 V output of the MC55 Touch S can be enabled for each tier and each individual escalation level.

1. Enable the **Output** option in the desired tier or escalation level.

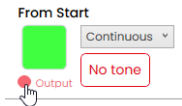

2. If necessary, switch between **Output Mode: ON 24V/200 mA** and **Output Mode: PULSE 24V/200mA**.

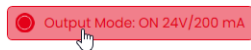

In **Pulse** mode, a pulse of at least 100 ms is applied to the output.

3. If necessary, switch between **Output: PNP** and **Output: NPN**.



Note

Damage to the MC55 Touch S

The MC55 Touch S can be damaged if the output is incorrectly configured.

1. Make sure that the output of the MC55 Touch S is configured to match the connected device or machine.

Switching	Description
PNP	<div style="display: flex; align-items: center;"> <div style="writing-mode: vertical-rl; transform: rotate(180deg); margin-right: 10px;">MC55 Touch</div> <div style="text-align: center;"> <p>PNP</p> </div> <div style="margin-left: 20px;"> <ul style="list-style-type: none"> – Positive switching – Positive load is connected to the output. </div> </div>
NPN	<div style="display: flex; align-items: center;"> <div style="writing-mode: vertical-rl; transform: rotate(180deg); margin-right: 10px;">MC55 Touch</div> <div style="text-align: center;"> <p>NPN</p> </div> <div style="margin-left: 20px;"> <ul style="list-style-type: none"> – Negative switching – Negative load is connected to the output. </div> </div>

5.5.9 Simulating signal inputs

Once all settings have been made, the signal inputs can be simulated.

The simulation shows the light effects, time-based escalations, the output and the sound output by means of a symbol.

1. Click on ► below the image of the MC55 Touch S.
→ The image of the MC55 Touch S shows the initial state and, if configured, the escalation levels after the corresponding time has elapsed.
2. Click on **Touch button** to simulate pressing the MC55 Touch S.
3. The image of the MC55 Touch S shows the configured behaviour.
4. Click on ■ below the image of the MC55 Touch S to stop the simulation.

5.5.10 Finalising a configuration

1. Make additional changes to the configuration as required.
2. Once all tiers are configured as desired, click on **Finalise**.
→ The **Finalise** window appears.

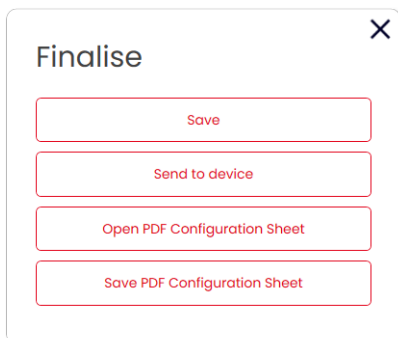

3. Click on **Save** to save the configuration in a configuration file.
4. Click on **Send to device** to transfer the configuration to the connected MC55 Touch S.
5. Click on **Open PDF Configuration Sheet** to display an overview of the current configuration.
6. Click on **Save PDF Configuration Sheet** to save the overview of the current configuration as a PDF file.

5.6 Creating a configuration from sample templates

The WERMA - Configuration Software provides several predefined configurations that can be transferred directly to a connected MC55 Touch S or used as a basis for your own configurations.

The following templates are available:

Template	Description
Button Configuration	<ul style="list-style-type: none"> – The MC55 Touch S is configured as a button. – A different state and the output are enabled in "On" mode as long as the MC55 Touch S is kept pressed. – A different colour is used for each signal input. <p>Possible application:</p> <ul style="list-style-type: none"> – Another device should only be enabled while pressing on the MC55 Touch S.
Switch Configuration	<ul style="list-style-type: none"> – The MC55 Touch S is configured as a switch. – A different state and the output are enabled in "On" mode when pressing on the MC55 Touch S. – A different colour is used for each signal input. – A maximum of 10 states can be created for each signal input. <p>Possible application:</p> <ul style="list-style-type: none"> – Give feedback to a control using the pulse output and in doing so switch the state of the MC55 Touch S or switch another device on/off.
Time-based escalation configuration	<ul style="list-style-type: none"> – The MC55 Touch S is configured as a button. – After 60 seconds, the MC55 Touch S flashes red and the output is enabled in "On" mode. – A maximum of 2 time-based escalations per state can be configured. <p>Possible application:</p> <ul style="list-style-type: none"> – If an error is not acknowledged after a certain time, a sound output can be connected to it and acknowledged again by pressing the MC55 Touch S. – Visualise time-critical work steps by changing the light pattern.
IO-Block Compatible	<ul style="list-style-type: none"> – The MC55 Touch S is configured as a switch. <p>Possible application:</p> <ul style="list-style-type: none"> – IO block – Signal input 1 is 24 V. – Signal input 3 is COM. – Signal inputs 2 and 4 indicate different colours.

1. Click on **Create from templates** in the **Configuration** area.

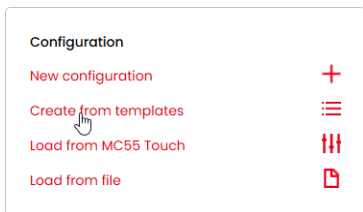

→ The **Create new configuration from templates** window appears.

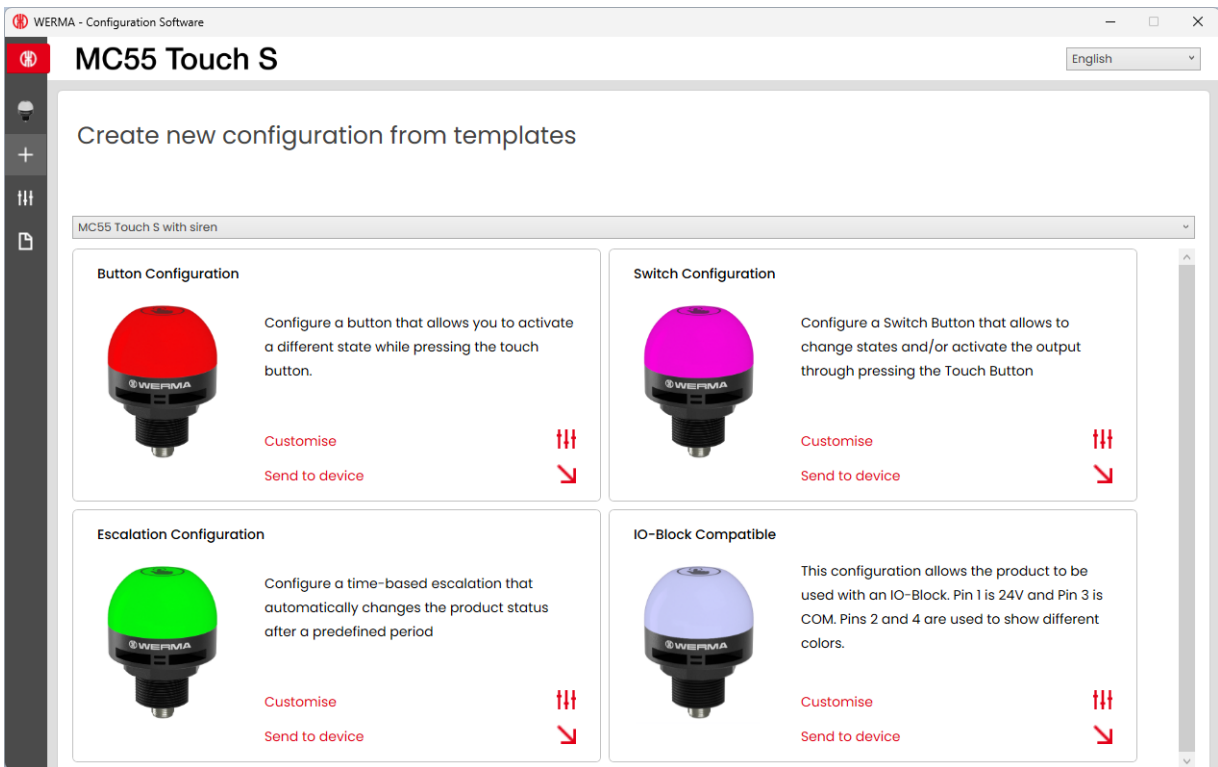

2. Select the variant of the MC55 Touch S.

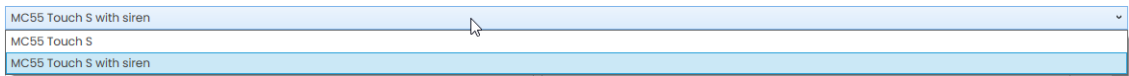

3. Click on **Customise** in the desired template to load and continue editing the template.
4. Click on **Send to device** to load the template and transfer it directly to the connected MC55 Touch S.



For more information on the configuration, see "Creating a new configuration", S. 161.

5.7 Loading the configuration of the connected MC55 Touch S

If an MC55 Touch S is connected to the computer, the WERMA - Configuration Software offers the option of opening the current configuration (for example the default setting) for editing. If no MC55 Touch S is connected, this menu item is faded out.

1. Click on **Load from MC55 Touch** in the **Configuration** area.

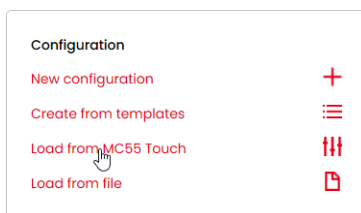

→ The **Configuration** window appears in the set mode and is already filled with the current configuration.



For more information on the configuration, see "Creating a new configuration", S. 161.

5.8 Opening an existing configuration

1. Click on **Load from file** in the **Configuration** area.

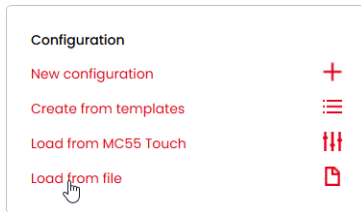

2. Select the desired configuration and click on **Open**.



Alternatively, the last used configurations can be displayed via the page menu (see "Overview", S. 159).

5.9 Updating the firmware



The computer must be connected to the Internet and an MC55 Touch S to perform a firmware update.

1. Click on **Check if new Firmware available** in the **Firmware** area.

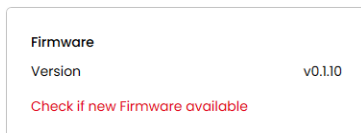

- The WERMA - Configuration Software checks for firmware updates for the connected MC55 Touch S.
- A corresponding message appears if an update is found.

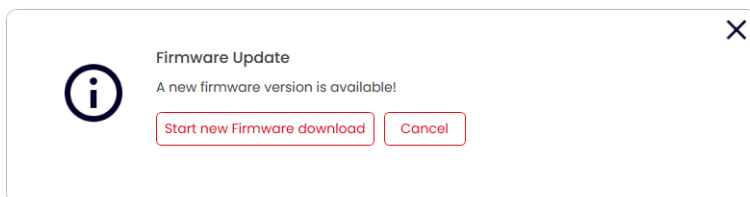

2. Click on **Start new Firmware download**.
 - The new firmware is transferred to the connected MC55 Touch S.

6 Updating the WERMA - Configuration Software



The computer must be connected to the Internet to perform a software update.

1. Click on **Check if new version available** in the **This software** area.



- The WERMA - Configuration Software checks for software updates.
- A corresponding message appears if an update is found.

7 Support



WERMA Signaltechnik GmbH + Co.KG

78604 Rietheim-Weilheim, Germany

Support: +49 (0)7424 / 9557-222

Fax: +49 (0)7424 / 9557-44

support@werma.com

www.werma.com



手册

WERMA - 配置软件

版本: 3.0 - 10/2024

310.657.006

声明

所有提及公司名称的内容仅用于说明目的。除下面列出的情况外，我们无意提及实际存在的组织。帮助文档中提及了以下公司和品牌：

– Microsoft Windows 10 和 Windows 11 是 Microsoft Corporation 的商标。

内容可能存在不准确或印刷错误，保留技术变更的权利。

© 版权所有 2024, WERMA Signaltechnik GmbH + Co.KG.

保留所有权利。

WERMA Signaltechnik GmbH + Co.KG

D-78604 Rietheim-Weilheim

电话 : +49 (0)7424 / 9557-222

传真 : +49 (0)7424 / 9557-44

support@werma.com

www.werma.com

目录

1 概述	184
1.1 功能	184
1.2 系统要求	184
2 安装 WERMA - 配置软件	185
3 运行 WERMA - 配置软件	185
4 配置 MC55 Touch S	186
4.1 功能	186
4.2 硬件说明	186
4.2.1 接口区域概览	186
4.2.2 概述:5 引脚 M12 连接器	187
4.2.3 默认设置	187
4.3 概述	188
4.3.1 配置区域	189
4.3.2 设备信息区域	189
4.3.3 支持区域	189
4.3.4 这个软件区域	189
4.3.5 固件区域	189
4.4 设置语言	189
4.5 创建新配置	190
4.5.1 选择信号输入	192
4.5.2 更改模式	193
4.5.3 调整状态	195
4.5.4 选择颜色	196
4.5.5 选择灯光效果	197
4.5.6 选择警报器	198
4.5.7 自定义时间型升级	199
4.5.8 激活输出	201
4.5.9 模拟控制	202
4.5.10 完成配置	202
4.6 从示例模板中导入配置	203
4.7 加载所连 MC55 Touch S 的配置	205
4.8 打开现有配置	206
4.9 更新固件	206
5 更新 WERMA - 配置软件	207
6 支持	208

1 概述

1.1 功能

WERMA - 配置软件 可以用来配置以下 WERMA 设备：

- eSIGN 信号灯柱
- MC55 Touch S

i 上述设备的供货情况因市场而异。

1.2 系统要求

操作系统	Windows 10 x86/x64 Windows 11 需更新至最新的 Windows 版本。
USB 接口	用于硬件配置。

i 会一直支持以上操作系统，除非 Microsoft 终止对上述系统的支持。

2 安装 WERMA - 配置软件

WERMA - 配置软件 无需安装, 可以作为便携版运行。

1. 可以通过以下网址下载 WERMA - 配置软件：
www.werma.com/software。

3 运行 WERMA - 配置软件

1. 双击 Werma-Konfigurator.exe。
→ WERMA - 配置软件 开始运行。



2. 选择所需设备。

4 配置 MC55 Touch S

4.1 功能

新款 MC55 Touch S 将彩色状态灯转变为可与操作员交互的交互式界面。借助直观的配置软件，用户可以通过设置不同的颜色、灯光效果和声音，以及时间型升级，轻松实现多种信号模式。

MC55 Touch S 支持多种应用场景，例如简单的音频警报确认、24 V 信号的切换、利用时间型升级进行流程模拟等，可满足各种不同需求。

4.2 硬件说明

硬件信息适用于以下产品：

- 240.160.55 MC55 Touch S 24VDC
- 240.170.55 MC55 Touch S 24VDC 带声音功能
- 240.260.55 MC55 Touch 24VDC NPN
- 240.270.55 MC55 Touch 24VDC NPN 带声音功能
- 240.280.55 MC55 Touch 24VDC PNP
- 240.290.55 MC55 Touch 24VDC PNP 带声音功能

4.2.1 接口区域概览

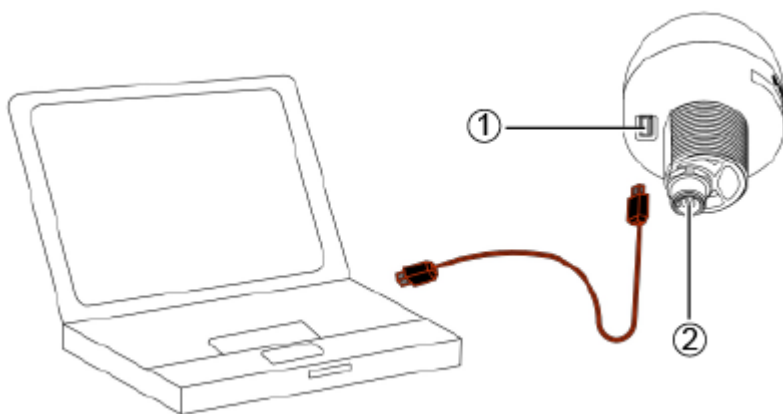

位号	描述
1	USB-C 端口
2	5 引脚 M12 连接器

4.2.2 概述:5 引脚 M12 连接器

MC55 Touch S 通过 5 引脚 M12 连接器连接, 引脚分配如下:

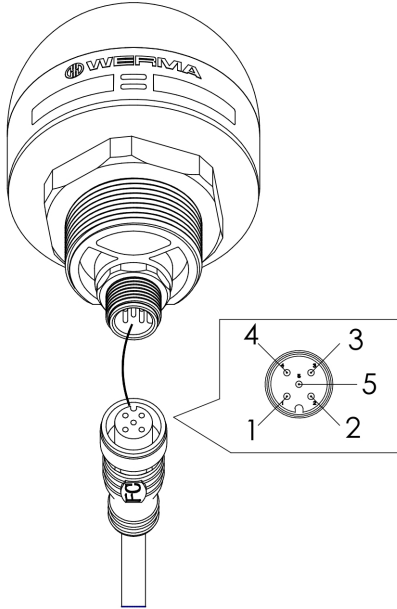

M12 引脚分配	多股彩色 M12 电缆线	功能
1	棕色	信号 1
2	白色	信号 2
3	蓝色	COM
4	黑色	输出 24 V, 200 mA
5	灰色	信号 3

4.2.3 默认设置

MC55 Touch S 默认以 开关 模式交付。激活触摸输入后, 输出端将切换为 24 V。

4.3 概述



位号	描述
1	所连接的 MC55 Touch S 的型号
2	配置 区域
3	设备信息 区域
4	设置语言
5	支持 区域
6	这个软件 区域
7	固件 区域
8	打开现有配置
9	加载 MC55 Touch S 的配置
10	从示例模板中导入配置
11	调出主屏幕
12	设备选择

4.3.1 配置区域

在配置区域中,有以下配置选项:

- **新的配置**:创建新配置(请参阅"创建新配置",第190页)。
- **从模板创建**:打开可立即传输到设备的标准模板(请参阅"从示例模板中导入配置",第203页)。
- **从MC55 Touch加载**:打开当前配置(可能是出厂设置)进行编辑(请参阅"加载所连MC55 Touch S的配置",第205页)。
- **从文件加载**:打开并再次使用现有配置(请参阅"打开现有配置",第206页)。

4.3.2 设备信息区域

在设备信息区域可访问手册和法律声明。

4.3.3 支持区域

支持区域显示 WERMA 支持团队的联系方式。

4.3.4 这个软件区域

这个软件区域显示 WERMA - 配置软件 当前版本信息,并提供配置软件更新选项。

4.3.5 固件区域

固件区域显示所连 MC55 Touch S 的固件信息,并提供固件更新选项。

4.4 设置语言

1. 在选择菜单中选择所需的语言。

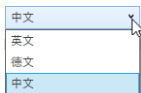

4.5 创建新配置

i 无论是否连接 MC55 Touch S, 都可以进行配置。

i MC55 Touch S 可以通过 USB 数据线连接到计算机, 同时通过 M12 电缆线连接到 24 V 电源。

1. 通过 USB 数据线将 MC55 Touch S 连接至计算机。
→ WERMA - 配置软件 会识别出已连接的 MC55 Touch S。



2. 如果 WERMA - 配置软件 无法识别所连接的 MC55 Touch S: 点击 **刷新连接的设备**。

未连接设备 

3. 点击 **配置** 区域的 **新的配置**。



→ **配置** 屏幕出现。

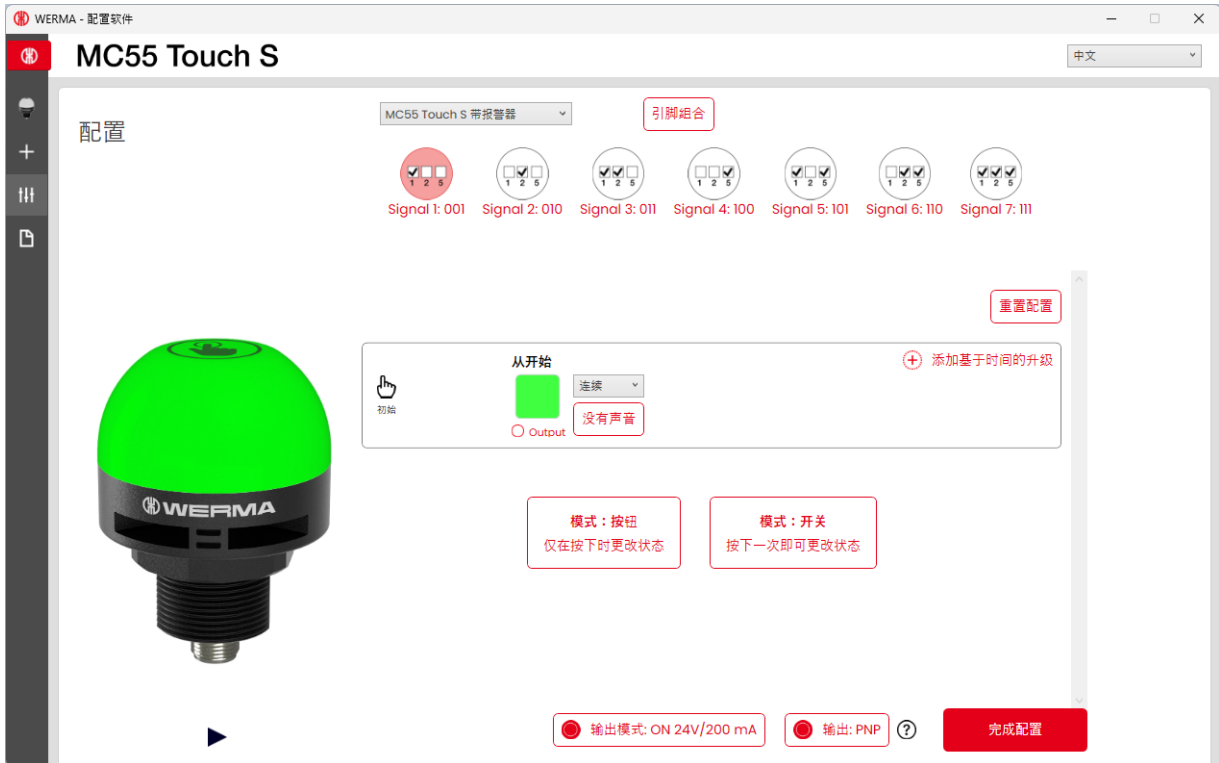

4. 如有必要, 选择要配置的 MC55TouchS 型号。



5. 选择 **模式:开关** 或 **模式:按钮**。

4.5.1 选择信号输入

每个信号输入均可单独配置。图标显示相应的引脚分配。

1. 单击所需的信号输入。



4.5.1.1 重命名信号输入

如有必要, 可以重命名信号输入并添加描述。

1. 单击信号输入概述上方的 **引脚组合**。



→ **引脚组合** 窗口出现。

引脚组合
✕

	简称	描述
Signal 1: 001	Signal 1	
Signal 2: 010	Signal 2	
Signal 3: 011	Signal 3	
Signal 4: 100	Signal 4	
Signal 5: 101	Signal 5	
Signal 6: 110	Signal 6	
Signal 7: 111	Signal 7	

保存

2. 在 **简称** 栏中输入所需的名称。

3. 在 **描述** 栏中输入信号描述。

4. 点击 **保存**。

4.5.2 更改模式

之后可以为每个信号输入选择 **按钮** 模式和 **开关** 模式。

4.5.2.1 按钮 模式

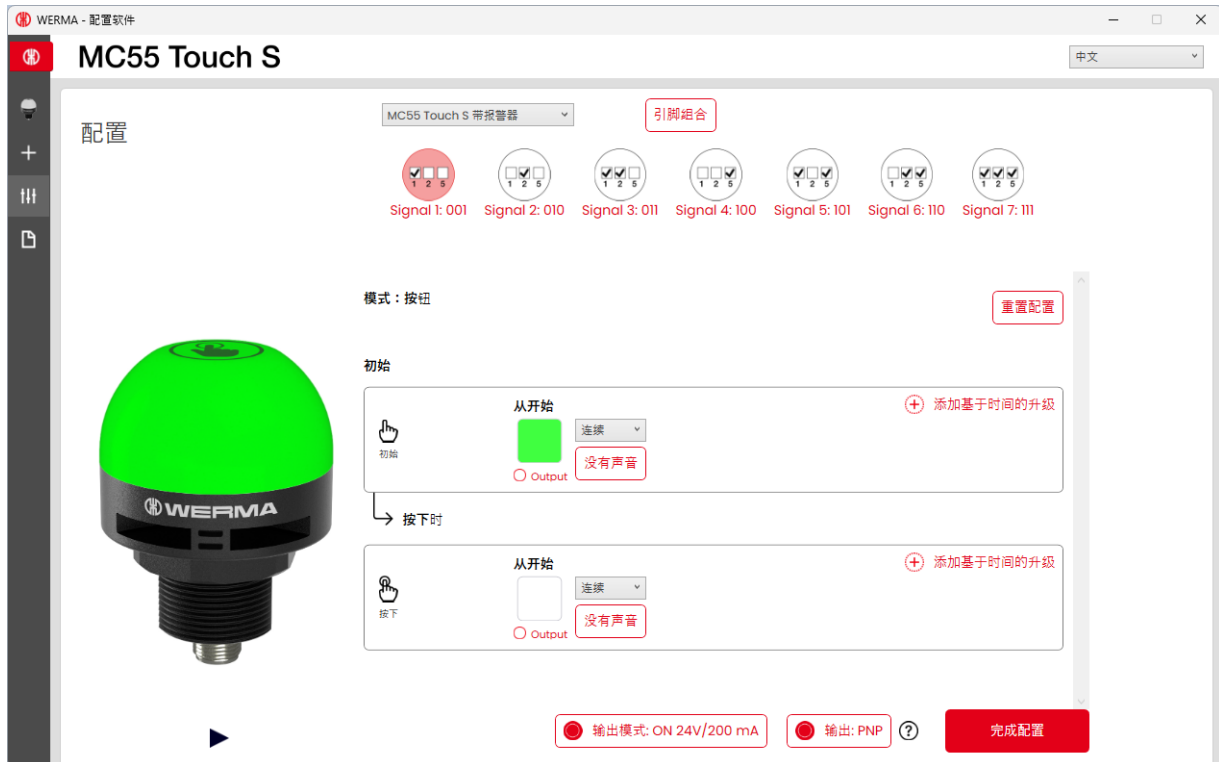

按钮 模式下可配置 2 种状态。

- 初始状态: 相应的信号输入通电且未按下 MC55 Touch S 时。
- 被按下状态: MC55 Touch S 被按下并保持按下的状态时。
- 松开 MC55 Touch S 后, 会变为初始状态。

可以设置每个状态的颜色、灯光效果、警报器(如果有)、时间型升级和输出。

4.5.2.2 开关模式

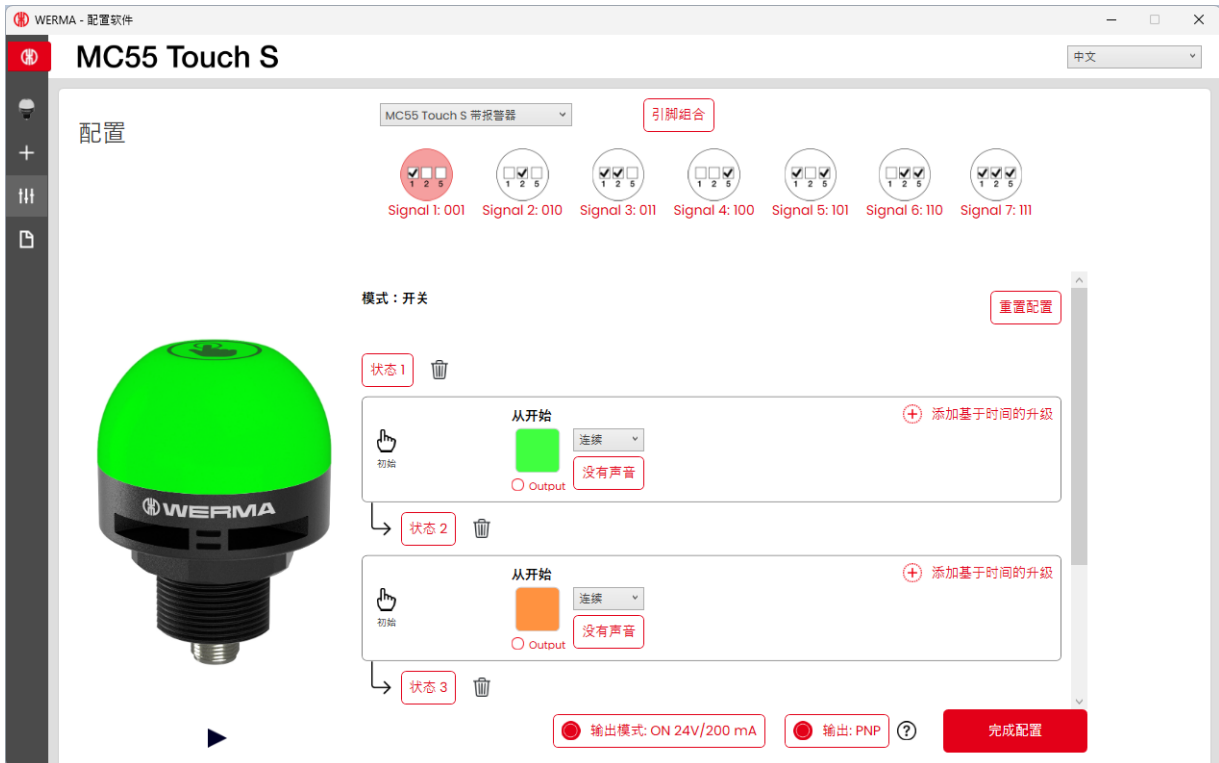

开关模式下可配置 10 种状态。每按一次 MC55 Touch S 即切换成下一个状态。

在开关模式下切换状态时, MC55 Touch S 会短暂亮起白色, 为触摸输入识别提供反馈。

可以设置每个状态的颜色、灯光效果、警报器(如果有)、时间型升级和输出。

i MC55 Touch S 出厂时标配为开关模式。激活触摸输入后, 输出端将切换为 24 V。

1. 在所需的信号输入中点击 **重置配置**。



2. 选择 **模式: 按钮** 或 **模式: 开关**。



4.5.3 调整状态

只能在 **开关** 模式中添加、删除或重命名状态。在 **按钮** 模式中，只有两种预定义状态，无法更改。

4.5.3.1 添加状态

1. 点击 **添加状态**。



4.5.3.2 删除状态

1. 在要删除的状态旁(例如**状态 3**)点击 .



4.5.3.3 重命名状态

1. 点击状态(例如**状态 1**)。
→ **状态 1**窗口出现。

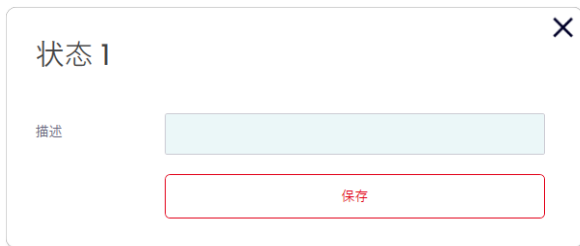

2. 在 **描述** 字段中输入所需的**状态名称**。
3. 点击 **保存**。



4.5.4 选择颜色

每个级别都可以分配一个默认颜色或自定义颜色。

1. 点击 **颜色** 列中的颜色字段。



→ **选择颜色** 窗口出现。



2. 选择是使用默认颜色还是自定义颜色。

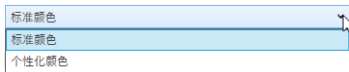

4.5.4.1 默认颜色

3. 单击所需的颜色字段。



有以下 8 种默认颜色可供选择：

- 红色
- 黄色
- 绿色
- 白色
- 蓝色
- 淡黄色
- 紫色
- 蓝绿色

4.5.4.2 自定义颜色

4. 在颜色字段中选择所需的颜色或在 **红**、**绿** 和 **蓝** 字段中输入相应的 RGB 值。



5. 点击 **选择颜色**。

4.5.5 选择灯光效果

1. 点击颜色字段旁边的选择菜单，选择所需的灯光效果。

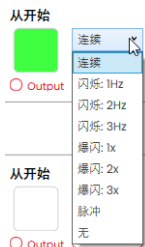

有以下 8 种灯光效果可供选择：

- 常亮
- 以 1 Hz 频率闪烁
- 以 2 Hz 频率闪烁
- 以 3 Hz 频率闪烁
- 闪光 1 次
- 闪光 2 次
- 闪光 3 次
- 呼吸式闪烁
- 无

 如果引脚分配仅用于声音或持续供电，则可以选择 **无** 设置。

4.5.6 选择警报器

如果所连或所选 MC55TouchS 有警报器，则可以选择一个信号音，它会在状态激活时响起。

1. 在所需的状态中点击 **没有声音**。











→ **选择声音** 窗口出现。

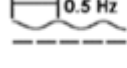

2. 选择所需的 **声音**。

有以下 10 种声音可供选择：

声音	频率	描述	最大分贝 (A)
1	 3.8 kHz	连续音	86
2	 0.9 kHz	连续音	70
3	 2.1 kHz	脉冲音	67
4	 0.9 kHz	脉冲音	68
5	 2.65 kHz	脉冲音	66
6	 0.9 kHz	脉冲音	70
7	 3.8 kHz	脉冲音	87
8	 2.3 kHz - 3.6 kHz	摇摆音	89
9	 2.65 kHz	连续音	67

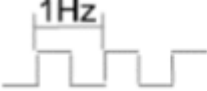
声音	频率	描述	最大分贝(A)
10	 1.2 kHz - 0.8 kHz	交替音	78

i 可以使用声音选择中的按钮 ▶ 来测试所选声音。声音会通过计算机播放。

3. 点击 **选择声音**。



4.5.7 自定义时间型升级

开关 模式或 按钮 模式中的每个状态最多可以配置两个时间型升级。
配置时间型升级后, 到达设定时间时, 会激活下一次升级。
可以配置每次升级的时间、灯光效果、颜色、警报器(如有)和输出。

4.5.7.1 添加时间型升级

1. 点击 **添加基于时间的升级**。



→ 已添加一个升级级别。



2. 单击 **10 秒后**。

→ **10 秒后**窗口出现。

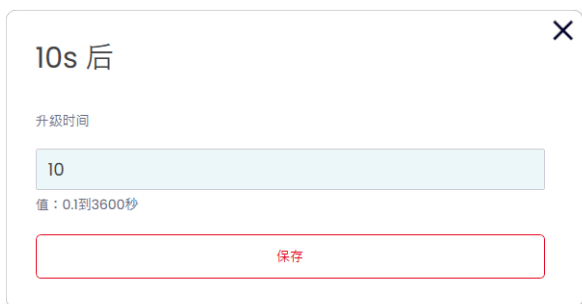

3. 在 **升级时间** 字段中输入此升级级别应在多少秒后开始。

4. 点击 **保存**。



5. 根据需要调整此升级级别的其他属性(颜色、灯光效果、输出和声音)。

6. 如有必要, 单击  以添加另一个升级级别。

4.5.7.2 删除时间型升级

如有需要, 可以删除最后一个升级级别。

1. 在最后一个升级级别中点击 **删除**。



4.5.8 激活输出

MC55 Touch S 的数字 24V 输出可针对每个级别或每个单独的升级级别激活。

1. 激活所需级别或升级级别的**输出**选项。



2. 如有必要，可在**输出模式: ON 24V/200 mA**和**输出模式: PULSE 24V/200mA**之间切换。



i 在**脉冲**模式下，输出将产生至少 100 ms 的脉冲信号。

3. 如有必要，可在**输出: PNP**和**输出: NPN**之间切换。



说明

MC55 Touch S 受损

MC55 Touch S 可能会因输出配置不当而受损。

1. 因此，请确保 MC55 Touch S 的输出配置与所连设备或机器相匹配。

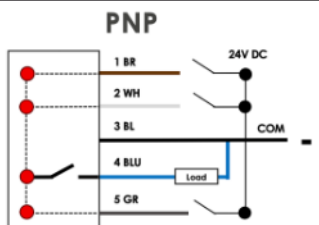
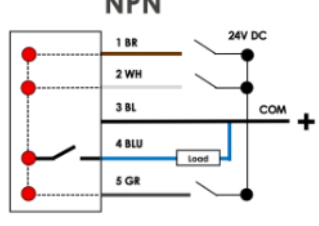
接线	描述
PNP	<div style="display: flex; align-items: center;"> <div style="writing-mode: vertical-rl; transform: rotate(180deg); margin-right: 10px;">MC55 Touch</div> <div style="text-align: center;">  </div> <div style="margin-left: 20px;"> <p>- 正向切换</p> <p>- 正负载切换到输出端。</p> </div> </div>
NPN	<div style="display: flex; align-items: center;"> <div style="writing-mode: vertical-rl; transform: rotate(180deg); margin-right: 10px;">MC55 Touch</div> <div style="text-align: center;">  </div> <div style="margin-left: 20px;"> <p>- 负向切换</p> <p>- 负负载切换到输出端。</p> </div> </div>

4.5.9 模拟控制

完成所有设置后, 可以进行控制模拟。

模拟会展示灯光效果、时间型升级、输出状态, 以及声音输出(用符号表示)。

1. 点击 MC55 Touch S 图像下方的 ▶。
→ MC55 Touch S 会显示初始状态, 以及经过相应时间后的升级级别(如果已配置)。
2. 点击**触摸按钮**即可模拟按下 MC55 Touch S 的操作。
3. MC55 Touch S 图像会显示已配置的行为。
4. 点击 MC55 Touch S 图像下方的 ■ 即可停止模拟。

4.5.10 完成配置

1. 如有需要, 可对配置进行进一步修改。
2. 根据需要, 配置完所有级别后, 点击 **完成**。
→ **完成** 窗口出现。



3. 点击 **保存**, 将配置保存到配置文件。
4. 点击 **发送到设备**, 将配置传输到所连的 MC55 Touch S。
5. 点击 **打开PDF配置表**, 查看当前配置的概述。
6. 点击 **保存PDF配置表**, 将当前配置的概述另存为 PDF 文件。

4.6 从示例模板中导入配置

WERMA-配置软件 提供多种预定义配置，这些配置可以直接传输到所连的 MC55 Touch S，也可以作为自定义配置的参考。

提供以下模板：

模板	描述
按钮配置	<ul style="list-style-type: none"> - MC55 Touch S 被配置为按钮。 - 按住 MC55 Touch S 时，会激活另一状态以及“开启”模式下的输出。 - 每个信号输入使用不同的颜色表示。 <p>可能的应用场景：</p> <ul style="list-style-type: none"> - 另一个设备仅在按住 MC55 Touch S 期间激活。
开关配置	<ul style="list-style-type: none"> - MC55 Touch S 被配置为开关。 - 按下 MC55 Touch S 时，会激活另一状态以及“开启”模式下的输出。 - 每个信号输入使用不同的颜色表示。 - 每个信号输入最多可以设置 10 种状态。 <p>可能的应用场景：</p> <ul style="list-style-type: none"> - 通过脉冲输出向控制器反馈，并在此过程中切换 MC55 Touch S 的状态，或控制另一个设备的开/关。
配置：时间型升级	<ul style="list-style-type: none"> - MC55 Touch S 被配置为按钮。 - 60 秒后，MC55 Touch S 呈红色闪烁，并且激活“开启”模式下的输出。 - 每个状态最多可以配置 2 个时间型升级。 <p>可能的应用场景：</p> <ul style="list-style-type: none"> - 如果错误在一定时间后仍未确认，可启动声音输出，以及按下 MC55 Touch S 来确认错误。 - 可以通过变化的灯光效果来实现时间敏感型工作步骤的可视化。
IO块兼容	<ul style="list-style-type: none"> - MC55 Touch S 被配置为开关。 <p>可能的应用场景：</p> <ul style="list-style-type: none"> - IO 模块 - 信号输入 1 为 24 V。 - 信号输入 3 为 COM。 - 信号输入 2 和 4 显示不同的颜色。

1. 点击 **配置** 区域的 **从模板创建**。



→ 从模板中新建配置 窗口出现。



2. 选择 MC55 Touch S 的型号。

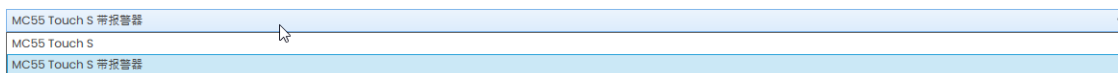

3. 点击所需模板上的 **定制**，以加载模板并继续编辑。
4. 点击 **发送到设备** 以加载模板，并直接将其传输到所连的 MC55 Touch S。

 有关配置的详细信息，请参阅“[创建新配置](#)”，第 190 页。

4.7 加载所连 MC55 Touch S 的配置

如果 MC55 Touch S 连接到计算机，WERMA - 配置软件会提供“打开当前配置(可能是出厂设置)进行编辑”选项。如果没有连接 MC55 Touch S，该菜单项将呈现灰色。

1. 点击 **配置** 区域的 **从MC55 Touch加载**。



→ **配置** 窗口会在已设置的模式下出现，并且已填充当前配置。

 有关配置的详细信息，请参阅“[创建新配置](#)”，第 190 页。

4.8 打开现有配置

1. 点击 **配置** 区域的 **从文件加载**。



2. 选择所需的配置文件并点击 **打开**。

 或者可以通过侧边菜单显示最近使用过的配置(请参阅"概述",第 188 页)。

4.9 更新固件

 要进行固件更新,计算机必须连接到互联网,且必须连接 MC55 Touch S。

1. 点击 **固件** 区域的 **检查新固件是否可用**。



- WERMA - 配置软件 会搜索所连的 MC55 Touch S 是否有固件更新。
- 发现有更新包后,会显示相应的消息。



2. 点击 **开始下载新固件**。
→ 新固件将传输至所连的 MC55 Touch S。

5 更新 WERMA - 配置软件

 要进行软件更新, 计算机必须连接到互联网。

1. 点击 **这个软件** 区域的 **检查新版本是否可用**。

- WERMA - 配置软件 会搜索软件更新。
- 发现有更新包后, 会显示相应的消息。

6 支持



WERMA Signaltechnik GmbH + Co.KG

D-78604 Rietheim-Weilheim

支持电话: +49 (0)7424 / 9557-222

传真: +49 (0)7424 / 9557-44

support@werma.com

www.werma.com

OSS License Agreement

INFORMATION AND NOTICES RELATED TO THE OPEN SOURCE SOFTWARE COMPONENTS CONTAINED IN THE DEVICE

The following list contains all open source software components used in the control system of the WERMA eSIGN signal tower and the MC55 Touch S, including the licence condition(s) under which the software may be used, as well as any copyright notices.

The control system of the WERMA eSIGN signal tower and the MC55 Touch S contains the following open source software components:

INFORMATION AND NOTICES RELATED TO THE OPEN SOURCE SOFTWARE COMPONENTS CONTAINED IN THE DEVICE1

- I. Newlib2
- II. Xtensa header files.....26
- III. Original parts of FreeRTOS26
- IV. FatFS library27
- V. SPIFFS library27
- VI. TLSF allocator Two Level Segregated Fit memory allocator28
- VII. HTTP Parser Based on src/http/nginx_http_parse.c.....29
- VIII. miniz.....29
- IX. tinyuf2.....30
- X. cJSON31
- XI. Xtensa libhal31
- XII. TinyBasic Plus32
- XIII. wpa_supplicant32
- XIV. TjpgDec33
- XV. tinyusb.....34

The applicable licence text is assigned to each open source software component below.

I. **Newlib**

The newlib subdirectory is a collection of software from several sources.

Each file may have its own copyright/license that is embedded in the source file. Unless otherwise noted in the body of the source file(s), the following copyright notices will apply to the contents of the newlib subdirectory:

1. Red Hat Incorporated

Copyright © 1994-2009 Red Hat, Inc. All rights reserved.

This copyrighted material is made available to anyone wishing to use, modify, copy, or redistribute it subject to the terms and conditions of the BSD License. This program is distributed in the hope that it will be useful, but WITHOUT ANY WARRANTY expressed or implied, including the implied warranties of MERCHANTABILITY or FITNESS FOR A PARTICULAR PURPOSE. A copy of this license is available at <http://www.opensource.org/licenses>. Any Red Hat trademarks that are incorporated in the source code or documentation are not subject to the BSD License and may only be used or replicated with the express permission of Red Hat, Inc.

2. University of California, Berkeley

Copyright © 1981-2000 The Regents of the University of California. All rights reserved.

Redistribution and use in source and binary forms, with or without modification, are permitted provided that the following conditions are met:

- Redistributions of source code must retain the above copyright notice, this list of conditions and the following disclaimer.
- Redistributions in binary form must reproduce the above copyright notice, this list of conditions and the following disclaimer in the documentation and/or other materials provided with the distribution.
- Neither the name of the University nor the names of its contributors may be used to endorse or promote products derived from this software without specific prior written permission.

THIS SOFTWARE IS PROVIDED BY THE COPYRIGHT HOLDERS AND CONTRIBUTORS "AS IS" AND ANY EXPRESS OR IMPLIED WARRANTIES, INCLUDING, BUT NOT LIMITED TO, THE IMPLIED WARRANTIES OF MERCHANTABILITY AND FITNESS FOR A PARTICULAR PURPOSE ARE DISCLAIMED. IN NO EVENT SHALL THE COPYRIGHT OWNER OR CONTRIBUTORS BE LIABLE FOR ANY DIRECT, INDIRECT, INCIDENTAL, SPECIAL, EXEMPLARY, OR CONSEQUENTIAL DAMAGES (INCLUDING, BUT NOT LIMITED TO, PROCUREMENT OF SUBSTITUTE GOODS OR SERVICES; LOSS OF USE, DATA, OR PROFITS; OR BUSINESS INTERRUPTION) HOWEVER CAUSED AND ON ANY THEORY OF LIABILITY, WHETHER IN CONTRACT, STRICT LIABILITY, OR TORT (INCLUDING NEGLIGENCE OR OTHERWISE) ARISING IN ANY WAY OUT OF THE USE OF THIS SOFTWARE, EVEN IF ADVISED OF THE POSSIBILITY OF SUCH DAMAGE.

3. David M. Gay (AT&T 1991, Lucent 1998)

The author of this software is David M. Gay.

Copyright © 1991 by AT&T.

Permission to use, copy, modify, and distribute this software for any purpose without fee is hereby granted, provided that this entire notice is included in all copies of any software which is or includes a copy or modification of this software and in all copies of the supporting documentation for such software.

THIS SOFTWARE IS BEING PROVIDED "AS IS", WITHOUT ANY EXPRESS OR IMPLIED WARRANTY. IN PARTICULAR, NEITHER THE AUTHOR NOR AT&T MAKES ANY REPRESENTATION OR WARRANTY OF ANY KIND CONCERNING THE MERCHANTABILITY OF THIS SOFTWARE OR ITS FITNESS FOR ANY PARTICULAR PURPOSE.

The author of this software is David M. Gay.

Copyright © 1998-2001 by Lucent Technologies All Rights Reserved

Permission to use, copy, modify, and distribute this software and its documentation for any purpose and without fee is hereby granted, provided that the above copyright notice appear in all copies and that both that the copyright notice and this permission notice and warranty disclaimer

appear in supporting documentation, and that the name of Lucent or any of its entities not be used in advertising or publicity pertaining to distribution of the software without specific, written prior permission.

LUCENT DISCLAIMS ALL WARRANTIES WITH REGARD TO THIS SOFTWARE, INCLUDING ALL IMPLIED WARRANTIES OF MERCHANTABILITY AND FITNESS. IN NO EVENT SHALL LUCENT OR ANY OF ITS ENTITIES BE LIABLE FOR ANY SPECIAL, INDIRECT OR CONSEQUENTIAL DAMAGES OR ANY DAMAGES WHATSOEVER RESULTING FROM LOSS OF USE, DATA OR PROFITS, WHETHER IN AN ACTION OF CONTRACT, NEGLIGENCE OR OTHER TORTIOUS ACTION, ARISING OUT OF OR IN CONNECTION WITH THE USE OR PERFORMANCE OF THIS SOFTWARE.

4. Advanced Micro Devices

Copyright 1989, 1990 Advanced Micro Devices, Inc.

This software is the property of Advanced Micro Devices, Inc (AMD) which specifically grants the user the right to modify, use and distribute this software provided this notice is not removed or altered. All other rights are reserved by AMD.

AMD MAKES NO WARRANTY OF ANY KIND, EXPRESS OR IMPLIED, WITH REGARD TO THIS SOFTWARE. IN NO EVENT SHALL AMD BE LIABLE FOR INCIDENTAL OR CONSEQUENTIAL DAMAGES IN CONNECTION WITH OR ARISING FROM THE FURNISHING, PERFORMANCE, OR USE OF THIS SOFTWARE.

So that all may benefit from your experience, please report any problems or suggestions about this software to the 29K Technical Support Center at 800-29-29-AMD (800-292-9263) in the USA, or 0800-89-1131 in the UK, or 0031-11-1129 in Japan, toll free. The direct dial number is 512-462-4118.

Advanced Micro Devices, Inc.
29K Support Products
Mail Stop 573
5900 E. Ben White Blvd.
Austin, TX 78741
800-292-9263

5. [blank]

6. [blank]

7. Sun Microsystems

Copyright © 1993 by Sun Microsystems, Inc. All rights reserved.

Developed at SunPro, a Sun Microsystems, Inc. business. Permission to use, copy, modify, and distribute this software is freely granted, provided that this notice is preserved.

8. Hewlett Packard

© Copyright 1986 HEWLETT-PACKARD COMPANY

To anyone who acknowledges that this file is provided "AS IS" without any express or implied warranty: permission to use, copy, modify, and distribute this file for any purpose is hereby granted without fee, provided that the above copyright notice and this notice appears in all copies, and that the name of Hewlett-Packard Company not be used in advertising or publicity pertaining to distribution of the software without specific, written prior permission. Hewlett-Packard Company makes no representations about the suitability of this software for any purpose.

9. Hans-Peter Nilsson

Copyright © 2001 Hans-Peter Nilsson

Permission to use, copy, modify, and distribute this software is freely granted, provided that the above copyright notice, this notice and the following disclaimer are preserved with no changes.

THIS SOFTWARE IS PROVIDED ``AS IS" AND WITHOUT ANY EXPRESS OR IMPLIED WARRANTIES, INCLUDING, WITHOUT LIMITATION, THE IMPLIED WARRANTIES OF MERCHANTABILITY AND FITNESS FOR A PARTICULAR PURPOSE.

10. Stephane Carrez (m68hc11-elf/m68hc12-elf targets only)

Copyright © 1999, 2000, 2001, 2002 Stephane Carrez (stcarrez@nerim.fr)

The authors hereby grant permission to use, copy, modify, distribute, and license this software and its documentation for any purpose, provided that existing copyright notices are retained in all copies and that this notice is included verbatim in any distributions. No written agreement, license, or royalty fee is required for any of the authorized uses. Modifications to this software may be copyrighted by their authors and need not follow the licensing terms described here, provided that the new terms are clearly indicated on the first page of each file where they apply.

11. Christopher G. Demetriou

Copyright © 2001 Christopher G. Demetriou All rights reserved.

Redistribution and use in source and binary forms, with or without modification, are permitted provided that the following conditions are met:

1. Redistributions of source code must retain the above copyright notice, this list of conditions and the following disclaimer.
2. Redistributions in binary form must reproduce the above copyright notice, this list of conditions and the following disclaimer in the documentation and/or other materials provided with the distribution.
3. The name of the author may not be used to endorse or promote products derived from this software without specific prior written permission.

THIS SOFTWARE IS PROVIDED BY THE AUTHOR ``AS IS" AND ANY EXPRESS OR IMPLIED WARRANTIES, INCLUDING, BUT NOT LIMITED TO, THE IMPLIED WARRANTIES OF MERCHANTABILITY AND FITNESS FOR A PARTICULAR PURPOSE ARE DISCLAIMED. IN NO EVENT SHALL THE AUTHOR BE LIABLE FOR ANY DIRECT, INDIRECT, INCIDENTAL, SPECIAL, EXEMPLARY, OR CONSEQUENTIAL DAMAGES (INCLUDING, BUT NOT LIMITED TO, PROCUREMENT OF SUBSTITUTE GOODS OR SERVICES; LOSS OF USE, DATA, OR PROFITS; OR BUSINESS INTERRUPTION) HOWEVER CAUSED AND ON ANY THEORY OF LIABILITY, WHETHER IN CONTRACT, STRICT LIABILITY, OR TORT (INCLUDING NEGLIGENCE OR OTHERWISE) ARISING IN ANY WAY OUT OF THE USE OF THIS SOFTWARE, EVEN IF ADVISED OF THE POSSIBILITY OF SUCH DAMAGE.

12. SuperH, Inc.

Copyright 2002 SuperH, Inc. All rights reserved

This software is the property of SuperH, Inc (SuperH) which specifically grants the user the right to modify, use and distribute this software provided this notice is not removed or altered. All other rights are reserved by SuperH.

SUPERH MAKES NO WARRANTY OF ANY KIND, EXPRESS OR IMPLIED, WITH REGARD TO THIS SOFTWARE. IN NO EVENT SHALL SUPERH BE LIABLE FOR INDIRECT, SPECIAL, INCIDENTAL OR CONSEQUENTIAL DAMAGES IN CONNECTION WITH OR ARISING FROM THE FURNISHING, PERFORMANCE, OR USE OF THIS SOFTWARE.

So that all may benefit from your experience, please report any problems or suggestions about this software to the SuperH Support Center via e-mail at softwaresupport@superh.com.

SuperH, Inc.
405 River Oaks Parkway
San Jose
CA 95134
USA

13. Royal Institute of Technology

Copyright © 1999 Kungliga Tekniska Högskolan
(Royal Institute of Technology, Stockholm, Sweden).

All rights reserved.

Redistribution and use in source and binary forms, with or without modification, are permitted provided that the following conditions are met:

1. Redistributions of source code must retain the above copyright notice, this list of conditions and the following disclaimer.
2. Redistributions in binary form must reproduce the above copyright notice, this list of conditions and the following disclaimer in the documentation and/or other materials provided with the distribution.

3. Neither the name of KTH nor the names of its contributors may be used to endorse or promote products derived from this software without specific prior written permission.

THIS SOFTWARE IS PROVIDED BY KTH AND ITS CONTRIBUTORS ``AS IS" AND ANY EXPRESS OR IMPLIED WARRANTIES, INCLUDING, BUT NOT LIMITED TO, THE IMPLIED WARRANTIES OF MERCHANTABILITY AND FITNESS FOR A PARTICULAR PURPOSE ARE DISCLAIMED. IN NO EVENT SHALL KTH OR ITS CONTRIBUTORS BE LIABLE FOR ANY DIRECT, INDIRECT, INCIDENTAL, SPECIAL, EXEMPLARY, OR CONSEQUENTIAL DAMAGES (INCLUDING, BUT NOT LIMITED TO, PROCUREMENT OF SUBSTITUTE GOODS OR SERVICES; LOSS OF USE, DATA, OR PROFITS; OR BUSINESS INTERRUPTION) HOWEVER CAUSED AND ON ANY THEORY OF LIABILITY, WHETHER IN CONTRACT, STRICT LIABILITY, OR TORT (INCLUDING NEGLIGENCE OR OTHERWISE) ARISING IN ANY WAY OUT OF THE USE OF THIS SOFTWARE, EVEN IF ADVISED OF THE POSSIBILITY OF SUCH DAMAGE.

14. Alexey Zelkin

Copyright © 2000, 2001 Alexey Zelkin <phantom@FreeBSD.org> All rights reserved.

Redistribution and use in source and binary forms, with or without modification, are permitted provided that the following conditions are met:

1. Redistributions of source code must retain the above copyright notice, this list of conditions and the following disclaimer.
2. Redistributions in binary form must reproduce the above copyright notice, this list of conditions and the following disclaimer in the documentation and/or other materials provided with the distribution.

THIS SOFTWARE IS PROVIDED BY THE AUTHOR AND CONTRIBUTORS ``AS IS" AND ANY EXPRESS OR IMPLIED WARRANTIES, INCLUDING, BUT NOT LIMITED TO, THE IMPLIED WARRANTIES OF MERCHANTABILITY AND FITNESS FOR A PARTICULAR PURPOSE ARE DISCLAIMED. IN NO EVENT SHALL THE AUTHOR OR CONTRIBUTORS BE LIABLE FOR ANY DIRECT, INDIRECT, INCIDENTAL, SPECIAL, EXEMPLARY, OR CONSEQUENTIAL DAMAGES (INCLUDING, BUT NOT LIMITED TO, PROCUREMENT OF SUBSTITUTE GOODS OR SERVICES; LOSS OF USE, DATA, OR PROFITS; OR BUSINESS INTERRUPTION) HOWEVER

CAUSED AND ON ANY THEORY OF LIABILITY, WHETHER IN CONTRACT, STRICT LIABILITY, OR TORT (INCLUDING NEGLIGENCE OR OTHERWISE) ARISING IN ANY WAY OUT OF THE USE OF THIS SOFTWARE, EVEN IF ADVISED OF THE POSSIBILITY OF SUCH DAMAGE.

15. Andrey A. Chernov

Copyright © 1997 by Andrey A. Chernov, Moscow, Russia. All rights reserved.

Redistribution and use in source and binary forms, with or without modification, are permitted provided that the following conditions are met:

1. Redistributions of source code must retain the above copyright notice, this list of conditions and the following disclaimer.
2. Redistributions in binary form must reproduce the above copyright notice, this list of conditions and the following disclaimer in the documentation and/or other materials provided with the distribution.

THIS SOFTWARE IS PROVIDED BY THE AUTHOR ``AS IS" AND ANY EXPRESS OR IMPLIED WARRANTIES, INCLUDING, BUT NOT LIMITED TO, THE IMPLIED WARRANTIES OF MERCHANTABILITY AND FITNESS FOR A PARTICULAR PURPOSE ARE DISCLAIMED. IN NO EVENT SHALL THE REGENTS OR CONTRIBUTORS BE LIABLE FOR ANY DIRECT, INDIRECT, INCIDENTAL, SPECIAL, EXEMPLARY, OR CONSEQUENTIAL DAMAGES (INCLUDING, BUT NOT LIMITED TO, PROCUREMENT OF SUBSTITUTE GOODS OR SERVICES; LOSS OF USE, DATA, OR PROFITS; OR BUSINESS INTERRUPTION) HOWEVER CAUSED AND ON ANY THEORY OF LIABILITY, WHETHER IN CONTRACT, STRICT LIABILITY, OR TORT (INCLUDING NEGLIGENCE OR OTHERWISE) ARISING IN ANY WAY OUT OF THE USE OF THIS SOFTWARE, EVEN IF ADVISED OF THE POSSIBILITY OF SUCH DAMAGE.

16. FreeBSD

Copyright © 1997-2002 FreeBSD Project. All rights reserved.

Redistribution and use in source and binary forms, with or without modification, are permitted provided that the following conditions are met:

1. Redistributions of source code must retain the above copyright notice, this list of conditions and the following disclaimer.
2. Redistributions in binary form must reproduce the above copyright notice, this list of conditions and the following disclaimer in the documentation and/or other materials provided with the distribution.

THIS SOFTWARE IS PROVIDED BY THE AUTHOR AND CONTRIBUTORS ``AS IS'' AND ANY EXPRESS OR IMPLIED WARRANTIES, INCLUDING, BUT NOT LIMITED TO, THE IMPLIED WARRANTIES OF MERCHANTABILITY AND FITNESS FOR A PARTICULAR PURPOSE ARE DISCLAIMED. IN NO EVENT SHALL THE AUTHOR OR CONTRIBUTORS BE LIABLE FOR ANY DIRECT, INDIRECT, INCIDENTAL, SPECIAL, EXEMPLARY, OR CONSEQUENTIAL DAMAGES (INCLUDING, BUT NOT LIMITED TO, PROCUREMENT OF SUBSTITUTE GOODS OR SERVICES; LOSS OF USE, DATA, OR PROFITS; OR BUSINESS INTERRUPTION) HOWEVER CAUSED AND ON ANY THEORY OF LIABILITY, WHETHER IN CONTRACT, STRICT LIABILITY, OR TORT (INCLUDING NEGLIGENCE OR OTHERWISE) ARISING IN ANY WAY OUT OF THE USE OF THIS SOFTWARE, EVEN IF ADVISED OF THE POSSIBILITY OF SUCH DAMAGE.

17. S. L. Moshier

Author: S. L. Moshier.

Copyright © 1984,2000 S.L. Moshier

Permission to use, copy, modify, and distribute this software for any purpose without fee is hereby granted, provided that this entire notice is included in all copies of any software which is or includes a copy or modification of this software and in all copies of the supporting documentation for such software.

THIS SOFTWARE IS BEING PROVIDED "AS IS", WITHOUT ANY EXPRESS OR IMPLIED WARRANTY. IN PARTICULAR, THE AUTHOR MAKES NO REPRESENTATION OR WARRANTY OF ANY KIND CONCERNING THE MERCHANTABILITY OF THIS SOFTWARE OR ITS FITNESS FOR ANY PARTICULAR PURPOSE.

18. Citrus Project

Copyright © 1999 Citrus Project, All rights reserved.

Redistribution and use in source and binary forms, with or without modification, are permitted provided that the following conditions are met:

1. Redistributions of source code must retain the above copyright notice, this list of conditions and the following disclaimer.
2. Redistributions in binary form must reproduce the above copyright notice, this list of conditions and the following disclaimer in the documentation and/or other materials provided with the distribution.

THIS SOFTWARE IS PROVIDED BY THE AUTHOR AND CONTRIBUTORS ``AS IS'' AND ANY EXPRESS OR IMPLIED WARRANTIES, INCLUDING, BUT NOT LIMITED TO, THE IMPLIED WARRANTIES OF MERCHANTABILITY AND FITNESS FOR A PARTICULAR PURPOSE ARE DISCLAIMED. IN NO EVENT SHALL THE AUTHOR OR CONTRIBUTORS BE LIABLE FOR ANY DIRECT, INDIRECT, INCIDENTAL, SPECIAL, EXEMPLARY, OR CONSEQUENTIAL DAMAGES (INCLUDING, BUT NOT LIMITED TO, PROCUREMENT OF SUBSTITUTE GOODS OR SERVICES; LOSS OF USE, DATA, OR PROFITS; OR BUSINESS INTERRUPTION) HOWEVER CAUSED AND ON ANY THEORY OF LIABILITY, WHETHER IN CONTRACT, STRICT LIABILITY, OR TORT (INCLUDING NEGLIGENCE OR OTHERWISE) ARISING IN ANY WAY OUT OF THE USE OF THIS SOFTWARE, EVEN IF ADVISED OF THE POSSIBILITY OF SUCH DAMAGE.

19. Todd C. Miller

Copyright © 1998 Todd C. Miller <Todd.Miller@courtesan.com>

All rights reserved.

Redistribution and use in source and binary forms, with or without modification, are permitted provided that the following conditions are met:

1. Redistributions of source code must retain the above copyright notice, this list of conditions and the following disclaimer.
2. Redistributions in binary form must reproduce the above copyright notice, this list of conditions and the following disclaimer in the documentation and/or other materials provided with the distribution.

3. The name of the author may not be used to endorse or promote products derived from this software without specific prior written permission.

THIS SOFTWARE IS PROVIDED ``AS IS" AND ANY EXPRESS OR IMPLIED WARRANTIES, INCLUDING, BUT NOT LIMITED TO, THE IMPLIED WARRANTIES OF MERCHANTABILITY AND FITNESS FOR A PARTICULAR PURPOSE ARE DISCLAIMED. IN NO EVENT SHALL THE AUTHOR BE LIABLE FOR ANY DIRECT, INDIRECT, INCIDENTAL, SPECIAL, EXEMPLARY, OR CONSEQUENTIAL DAMAGES (INCLUDING, BUT NOT LIMITED TO, PROCUREMENT OF SUBSTITUTE GOODS OR SERVICES; LOSS OF USE, DATA, OR PROFITS; OR BUSINESS INTERRUPTION) HOWEVER CAUSED AND ON ANY THEORY OF LIABILITY, WHETHER IN CONTRACT, STRICT LIABILITY, OR TORT (INCLUDING NEGLIGENCE OR OTHERWISE) ARISING IN ANY WAY OUT OF THE USE OF THIS SOFTWARE, EVEN IF ADVISED OF THE POSSIBILITY OF SUCH DAMAGE.

20. DJ Delorie (i386)

Copyright © 1991 DJ Delorie All rights reserved.

Redistribution, modification, and use in source and binary forms is permitted provided that the above copyright notice and following paragraph are duplicated in all such forms.

This file is distributed WITHOUT ANY WARRANTY; without even the implied warranty of MERCHANTABILITY or FITNESS FOR A PARTICULAR PURPOSE.

21. Free Software Foundation LGPL License (*-linux* targets only)

Copyright © 1990-1999, 2000, 2001 Free Software Foundation, Inc.

This file is part of the GNU C Library.

Contributed by Mark Kettenis <kettenis@phys.uva.nl>, 1997.

The GNU C Library is free software; you can redistribute it and/or modify it under the terms of the GNU Lesser General Public License as published by the Free Software Foundation; either version 2.1 of the License, or (at your option) any later version.

The GNU C Library is distributed in the hope that it will be useful, but WITHOUT ANY WARRANTY; without even the implied warranty of MERCHANTABILITY or FITNESS FOR A PARTICULAR PURPOSE. See the GNU Lesser General Public License for more details.

You should have received a copy of the GNU Lesser General Public License along with the GNU C Library; if not, write to the Free Software Foundation, Inc., 51 Franklin Street, Fifth Floor, Boston, MA 02110-1301 USA.

22. Xavier Leroy LGPL License (i[3456]86-*linux* targets only)

Copyright © 1996 Xavier Leroy (Xavier.Leroy@inria.fr)

This program is free software; you can redistribute it and/or modify it under the terms of the GNU Library General Public License as published by the Free Software Foundation; either version 2 of the License, or (at your option) any later version.

This program is distributed in the hope that it will be useful, but WITHOUT ANY WARRANTY; without even the implied warranty of MERCHANTABILITY or FITNESS FOR A PARTICULAR PURPOSE. See the GNU Library General Public License for more details.

23. Intel (i960)

Copyright © 1993 Intel Corporation

Intel hereby grants you permission to copy, modify, and distribute this software and its documentation. Intel grants this permission provided that the above copyright notice appears in all copies and that both the copyright notice and this permission notice appear in supporting documentation. In addition, Intel grants this permission provided that you prominently mark as "not part of the original" any modifications made to this software or documentation, and that the name of Intel Corporation not be used in advertising or publicity pertaining to distribution of the software or the documentation without specific, written prior permission.

Intel Corporation provides this AS IS, WITHOUT ANY WARRANTY, EXPRESS OR IMPLIED, INCLUDING, WITHOUT LIMITATION, ANY WARRANTY OF MERCHANTABILITY OR FITNESS FOR A PARTICULAR PURPOSE. Intel makes no

guarantee or representations regarding the use of, or the results of the use of, the software and documentation in terms of correctness, accuracy, reliability, currentness, or otherwise; and you rely on the software, documentation and results solely at your own risk.

IN NO EVENT SHALL INTEL BE LIABLE FOR ANY LOSS OF USE, LOSS OF BUSINESS, LOSS OF PROFITS, INDIRECT, INCIDENTAL, SPECIAL OR CONSEQUENTIAL DAMAGES OF ANY KIND. IN NO EVENT SHALL INTEL'S TOTAL LIABILITY EXCEED THE SUM PAID TO INTEL FOR THE PRODUCT LICENSED HEREUNDER.

24. Hewlett-Packard (hppa targets only)

© Copyright 1986 HEWLETT-PACKARD COMPANY

To anyone who acknowledges that this file is provided "AS IS" without any express or implied warranty: permission to use, copy, modify, and distribute this file for any purpose is hereby granted without fee, provided that the above copyright notice and this notice appears in all copies, and that the name of Hewlett-Packard Company not be used in advertising or publicity pertaining to distribution of the software without specific, written prior permission. Hewlett-Packard Company makes no representations about the suitability of this software for any purpose.

25. Henry Spencer (only *-linux targets)

Copyright 1992, 1993, 1994 Henry Spencer. All rights reserved.

This software is not subject to any license of the American Telephone and Telegraph Company or of the Regents of the University of California.

Permission is granted to anyone to use this software for any purpose on any computer system, and to alter it and redistribute it, subject to the following restrictions:

1. The author is not responsible for the consequences of use of this software, no matter how awful, even if they arise from flaws in it.
2. The origin of this software must not be misrepresented, either by explicit claim or by omission. Since few users ever read sources, credits must appear in the documentation.

3. Altered versions must be plainly marked as such, and must not be misrepresented as being the original software. Since few users ever read sources, credits must appear in the documentation.
4. This notice may not be removed or altered.

26. Mike Barcroft

Copyright © 2001 Mike Barcroft <mike@FreeBSD.org> All rights reserved.

Redistribution and use in source and binary forms, with or without modification, are permitted provided that the following conditions are met:

1. Redistributions of source code must retain the above copyright notice, this list of conditions and the following disclaimer.
2. Redistributions in binary form must reproduce the above copyright notice, this list of conditions and the following disclaimer in the documentation and/or other materials provided with the distribution.

THIS SOFTWARE IS PROVIDED BY THE AUTHOR AND CONTRIBUTORS ``AS IS'' AND ANY EXPRESS OR IMPLIED WARRANTIES, INCLUDING, BUT NOT LIMITED TO, THE IMPLIED WARRANTIES OF MERCHANTABILITY AND FITNESS FOR A PARTICULAR PURPOSE ARE DISCLAIMED. IN NO EVENT SHALL THE AUTHOR OR CONTRIBUTORS BE LIABLE FOR ANY DIRECT, INDIRECT, INCIDENTAL, SPECIAL, EXEMPLARY, OR CONSEQUENTIAL DAMAGES (INCLUDING, BUT NOT LIMITED TO, PROCUREMENT OF SUBSTITUTE GOODS OR SERVICES; LOSS OF USE, DATA, OR PROFITS; OR BUSINESS INTERRUPTION) HOWEVER CAUSED AND ON ANY THEORY OF LIABILITY, WHETHER IN CONTRACT, STRICT LIABILITY, OR TORT (INCLUDING NEGLIGENCE OR OTHERWISE) ARISING IN ANY WAY OUT OF THE USE OF THIS SOFTWARE, EVEN IF ADVISED OF THE POSSIBILITY OF SUCH DAMAGE.

27. Konstantin Chuguev (--enable-newlib-iconv)

Copyright © 1999, 2000 Konstantin Chuguev. All rights reserved.

Redistribution and use in source and binary forms, with or without modification, are permitted provided that the following conditions are met:

1. Redistributions of source code must retain the above copyright notice, this list of conditions and the following disclaimer.
2. Redistributions in binary form must reproduce the above copyright notice, this list of conditions and the following disclaimer in the documentation and/or other materials provided with the distribution.

THIS SOFTWARE IS PROVIDED BY THE AUTHOR AND CONTRIBUTORS ``AS IS'' AND ANY EXPRESS OR IMPLIED WARRANTIES, INCLUDING, BUT NOT LIMITED TO, THE IMPLIED WARRANTIES OF MERCHANTABILITY AND FITNESS FOR A PARTICULAR PURPOSE ARE DISCLAIMED. IN NO EVENT SHALL THE AUTHOR OR CONTRIBUTORS BE LIABLE FOR ANY DIRECT, INDIRECT, INCIDENTAL, SPECIAL, EXEMPLARY, OR CONSEQUENTIAL DAMAGES (INCLUDING, BUT NOT LIMITED TO, PROCUREMENT OF SUBSTITUTE GOODS OR SERVICES; LOSS OF USE, DATA, OR PROFITS; OR BUSINESS INTERRUPTION) HOWEVER CAUSED AND ON ANY THEORY OF LIABILITY, WHETHER IN CONTRACT, STRICT LIABILITY, OR TORT (INCLUDING NEGLIGENCE OR OTHERWISE) ARISING IN ANY WAY OUT OF THE USE OF THIS SOFTWARE, EVEN IF ADVISED OF THE POSSIBILITY OF SUCH DAMAGE.

iconv (Charset Conversion Library) v2.0

28. Artem Bityuckiy (--enable-newlib-iconv)

Copyright © 2003, Artem B. Bityuckiy, SoftMine Corporation.

Rights transferred to Franklin Electronic Publishers.

Redistribution and use in source and binary forms, with or without modification, are permitted provided that the following conditions are met:

1. Redistributions of source code must retain the above copyright notice, this list of conditions and the following disclaimer.
2. Redistributions in binary form must reproduce the above copyright notice, this list of conditions and the following disclaimer in the documentation and/or other materials provided with the distribution.

THIS SOFTWARE IS PROVIDED BY THE AUTHOR AND CONTRIBUTORS ``AS IS'' AND ANY EXPRESS OR IMPLIED WARRANTIES, INCLUDING, BUT NOT LIMITED TO, THE IMPLIED WARRANTIES OF MERCHANTABILITY AND FITNESS FOR A

PARTICULAR PURPOSE ARE DISCLAIMED. IN NO EVENT SHALL THE AUTHOR OR CONTRIBUTORS BE LIABLE FOR ANY DIRECT, INDIRECT, INCIDENTAL, SPECIAL, EXEMPLARY, OR CONSEQUENTIAL DAMAGES (INCLUDING, BUT NOT LIMITED TO, PROCUREMENT OF SUBSTITUTE GOODS OR SERVICES; LOSS OF USE, DATA, OR PROFITS; OR BUSINESS INTERRUPTION) HOWEVER CAUSED AND ON ANY THEORY OF LIABILITY, WHETHER IN CONTRACT, STRICT LIABILITY, OR TORT (INCLUDING NEGLIGENCE OR OTHERWISE) ARISING IN ANY WAY OUT OF THE USE OF THIS SOFTWARE, EVEN IF ADVISED OF THE POSSIBILITY OF SUCH DAMAGE.

29. IBM, Sony, Toshiba (only spu-* targets)

© Copyright 2001,2006, International Business Machines Corporation, Sony Computer Entertainment, Incorporated, Toshiba Corporation, All rights reserved.

Redistribution and use in source and binary forms, with or without modification, are permitted provided that the following conditions are met:

- Redistributions of source code must retain the above copyright notice, this list of conditions and the following disclaimer.
- Redistributions in binary form must reproduce the above copyright notice, this list of conditions and the following disclaimer in the documentation and/or other materials provided with the distribution.
- Neither the names of the copyright holders nor the names of their contributors may be used to endorse or promote products derived from this software without specific prior written permission.

THIS SOFTWARE IS PROVIDED BY THE COPYRIGHT HOLDERS AND CONTRIBUTORS "AS IS" AND ANY EXPRESS OR IMPLIED WARRANTIES, INCLUDING, BUT NOT LIMITED TO, THE IMPLIED WARRANTIES OF MERCHANTABILITY AND FITNESS FOR A PARTICULAR PURPOSE ARE DISCLAIMED. IN NO EVENT SHALL THE COPYRIGHT OWNER OR CONTRIBUTORS BE LIABLE FOR ANY DIRECT, INDIRECT, INCIDENTAL, SPECIAL, EXEMPLARY, OR CONSEQUENTIAL DAMAGES (INCLUDING, BUT NOT LIMITED TO, PROCUREMENT OF SUBSTITUTE GOODS OR SERVICES; LOSS OF USE, DATA, OR PROFITS; OR BUSINESS INTERRUPTION) HOWEVER CAUSED AND ON ANY THEORY OF LIABILITY, WHETHER IN CONTRACT, STRICT LIABILITY, OR TORT (INCLUDING

NEGLIGENCE OR OTHERWISE) ARISING IN ANY WAY OUT OF THE USE OF THIS SOFTWARE, EVEN IF ADVISED OF THE POSSIBILITY OF SUCH DAMAGE.

30. Alex Tatmanjants (targets using libc/posix)

Copyright © 1995 Alex Tatmanjants <alex@elvisti.kiev.ua> at Electronni Visti IA, Kiev, Ukraine. All rights reserved.

Redistribution and use in source and binary forms, with or without modification, are permitted provided that the following conditions are met:

1. Redistributions of source code must retain the above copyright notice, this list of conditions and the following disclaimer.
2. Redistributions in binary form must reproduce the above copyright notice, this list of conditions and the following disclaimer in the documentation and/or other materials provided with the distribution.

THIS SOFTWARE IS PROVIDED BY THE AUTHOR ``AS IS" AND ANY EXPRESS OR IMPLIED WARRANTIES, INCLUDING, BUT NOT LIMITED TO, THE IMPLIED WARRANTIES OF MERCHANTABILITY AND FITNESS FOR A PARTICULAR PURPOSE ARE DISCLAIMED. IN NO EVENT SHALL THE AUTHOR BE LIABLE FOR ANY DIRECT, INDIRECT, INCIDENTAL, SPECIAL, EXEMPLARY, OR CONSEQUENTIAL DAMAGES (INCLUDING, BUT NOT LIMITED TO, PROCUREMENT OF SUBSTITUTE GOODS OR SERVICES; LOSS OF USE, DATA, OR PROFITS; OR BUSINESS INTERRUPTION) HOWEVER CAUSED AND ON ANY THEORY OF LIABILITY, WHETHER IN CONTRACT, STRICT LIABILITY, OR TORT (INCLUDING NEGLIGENCE OR OTHERWISE) ARISING IN ANY WAY OUT OF THE USE OF THIS SOFTWARE, EVEN IF ADVISED OF THE POSSIBILITY OF SUCH DAMAGE.

31. M. Warner Losh (targets using libc/posix)

Copyright © 1998, M. Warner Losh <imp@freebsd.org> All rights reserved.

Redistribution and use in source and binary forms, with or without modification, are permitted provided that the following conditions are met:

1. Redistributions of source code must retain the above copyright notice, this list of conditions and the following disclaimer.

2. Redistributions in binary form must reproduce the above copyright notice, this list of conditions and the following disclaimer in the documentation and/or other materials provided with the distribution.

THIS SOFTWARE IS PROVIDED BY THE AUTHOR AND CONTRIBUTORS ``AS IS" AND ANY EXPRESS OR IMPLIED WARRANTIES, INCLUDING, BUT NOT LIMITED TO, THE IMPLIED WARRANTIES OF MERCHANTABILITY AND FITNESS FOR A PARTICULAR PURPOSE ARE DISCLAIMED. IN NO EVENT SHALL THE AUTHOR OR CONTRIBUTORS BE LIABLE FOR ANY DIRECT, INDIRECT, INCIDENTAL, SPECIAL, EXEMPLARY, OR CONSEQUENTIAL DAMAGES (INCLUDING, BUT NOT LIMITED TO, PROCUREMENT OF SUBSTITUTE GOODS OR SERVICES; LOSS OF USE, DATA, OR PROFITS; OR BUSINESS INTERRUPTION) HOWEVER CAUSED AND ON ANY THEORY OF LIABILITY, WHETHER IN CONTRACT, STRICT LIABILITY, OR TORT (INCLUDING NEGLIGENCE OR OTHERWISE) ARISING IN ANY WAY OUT OF THE USE OF THIS SOFTWARE, EVEN IF ADVISED OF THE POSSIBILITY OF SUCH DAMAGE.

32. Andrey A. Chernov (targets using libc/posix)

Copyright © 1996 by Andrey A. Chernov, Moscow, Russia. All rights reserved.

Redistribution and use in source and binary forms, with or without modification, are permitted provided that the following conditions are met:

1. Redistributions of source code must retain the above copyright notice, this list of conditions and the following disclaimer.
2. Redistributions in binary form must reproduce the above copyright notice, this list of conditions and the following disclaimer in the documentation and/or other materials provided with the distribution.

THIS SOFTWARE IS PROVIDED BY THE AUTHOR ``AS IS" AND ANY EXPRESS OR IMPLIED WARRANTIES, INCLUDING, BUT NOT LIMITED TO, THE IMPLIED WARRANTIES OF MERCHANTABILITY AND FITNESS FOR A PARTICULAR PURPOSE ARE DISCLAIMED. IN NO EVENT SHALL THE REGENTS OR CONTRIBUTORS BE LIABLE FOR ANY DIRECT, INDIRECT, INCIDENTAL, SPECIAL, EXEMPLARY, OR CONSEQUENTIAL DAMAGES (INCLUDING, BUT NOT LIMITED TO, PROCUREMENT OF SUBSTITUTE GOODS OR SERVICES; LOSS OF USE, DATA, OR PROFITS; OR BUSINESS INTERRUPTION) HOWEVER CAUSED AND ON

ANY THEORY OF LIABILITY, WHETHER IN CONTRACT, STRICT LIABILITY, OR TORT (INCLUDING NEGLIGENCE OR OTHERWISE) ARISING IN ANY WAY OUT OF THE USE OF THIS SOFTWARE, EVEN IF ADVISED OF THE POSSIBILITY OF SUCH DAMAGE.

33. Daniel Eischen (targets using libc/posix)

Copyright © 2001 Daniel Eischen <deischen@FreeBSD.org>. All rights reserved.

Redistribution and use in source and binary forms, with or without modification, are permitted provided that the following conditions are met:

1. Redistributions of source code must retain the above copyright notice, this list of conditions and the following disclaimer.
2. Redistributions in binary form must reproduce the above copyright notice, this list of conditions and the following disclaimer in the documentation and/or other materials provided with the distribution.

THIS SOFTWARE IS PROVIDED BY THE AUTHOR AND CONTRIBUTORS ``AS IS'' AND ANY EXPRESS OR IMPLIED WARRANTIES, INCLUDING, BUT NOT LIMITED TO, THE IMPLIED WARRANTIES OF MERCHANTABILITY AND FITNESS FOR A PARTICULAR PURPOSE ARE DISCLAIMED. IN NO EVENT SHALL THE REGENTS OR CONTRIBUTORS BE LIABLE FOR ANY DIRECT, INDIRECT, INCIDENTAL, SPECIAL, EXEMPLARY, OR CONSEQUENTIAL DAMAGES (INCLUDING, BUT NOT LIMITED TO, PROCUREMENT OF SUBSTITUTE GOODS OR SERVICES; LOSS OF USE, DATA, OR PROFITS; OR BUSINESS INTERRUPTION) HOWEVER CAUSED AND ON ANY THEORY OF LIABILITY, WHETHER IN CONTRACT, STRICT LIABILITY, OR TORT (INCLUDING NEGLIGENCE OR OTHERWISE) ARISING IN ANY WAY OUT OF THE USE OF THIS SOFTWARE, EVEN IF ADVISED OF THE POSSIBILITY OF SUCH DAMAGE.

34. Jon Beniston (only lm32-* targets)

Contributed by Jon Beniston <jon@beniston.com> Redistribution and use in source and binary forms, with or without modification, are permitted provided that the following conditions are met:

1. Redistributions of source code must retain the above copyright notice, this list of conditions and the following disclaimer.

2. Redistributions in binary form must reproduce the above copyright notice, this list of conditions and the following disclaimer in the documentation and/or other materials provided with the distribution.

THIS SOFTWARE IS PROVIDED BY THE AUTHOR AND CONTRIBUTORS ``AS IS" AND ANY EXPRESS OR IMPLIED WARRANTIES, INCLUDING, BUT NOT LIMITED TO, THE IMPLIED WARRANTIES OF MERCHANTABILITY AND FITNESS FOR A PARTICULAR PURPOSE ARE DISCLAIMED. IN NO EVENT SHALL THE AUTHOR OR CONTRIBUTORS BE LIABLE FOR ANY DIRECT, INDIRECT, INCIDENTAL, SPECIAL, EXEMPLARY, OR CONSEQUENTIAL DAMAGES (INCLUDING, BUT NOT LIMITED TO, PROCUREMENT OF SUBSTITUTE GOODS OR SERVICES; LOSS OF USE, DATA, OR PROFITS; OR BUSINESS INTERRUPTION) HOWEVER CAUSED AND ON ANY THEORY OF LIABILITY, WHETHER IN CONTRACT, STRICT LIABILITY, OR TORT (INCLUDING NEGLIGENCE OR OTHERWISE) ARISING IN ANY WAY OUT OF THE USE OF THIS SOFTWARE, EVEN IF ADVISED OF THE POSSIBILITY OF SUCH DAMAGE.

35. ARM Ltd (arm and thumb variant targets only)

Copyright © 2009 ARM Ltd All rights reserved.

Redistribution and use in source and binary forms, with or without modification, are permitted provided that the following conditions are met:

1. Redistributions of source code must retain the above copyright notice, this list of conditions and the following disclaimer.
2. Redistributions in binary form must reproduce the above copyright notice, this list of conditions and the following disclaimer in the documentation and/or other materials provided with the distribution.
3. The name of the company may not be used to endorse or promote products derived from this software without specific prior written permission.

THIS SOFTWARE IS PROVIDED BY ARM LTD ``AS IS" AND ANY EXPRESS OR IMPLIED WARRANTIES, INCLUDING, BUT NOT LIMITED TO, THE IMPLIED WARRANTIES OF MERCHANTABILITY AND FITNESS FOR A PARTICULAR PURPOSE ARE DISCLAIMED. IN NO EVENT SHALL ARM LTD BE LIABLE FOR ANY DIRECT, INDIRECT, INCIDENTAL, SPECIAL, EXEMPLARY, OR CONSEQUENTIAL DAMAGES (INCLUDING, BUT NOT LIMITED TO, PROCUREMENT OF SUBSTITUTE

GOODS OR SERVICES; LOSS OF USE, DATA, OR PROFITS; OR BUSINESS INTERRUPTION) HOWEVER CAUSED AND ON ANY THEORY OF LIABILITY, WHETHER IN CONTRACT, STRICT LIABILITY, OR TORT (INCLUDING NEGLIGENCE OR OTHERWISE) ARISING IN ANY WAY OUT OF THE USE OF THIS SOFTWARE, EVEN IF ADVISED OF THE POSSIBILITY OF SUCH DAMAGE.

36. Xilinx, Inc. (microblaze-* and powerpc-* targets)

Copyright © 2004, 2009 Xilinx, Inc. All rights reserved.

Redistribution and use in source and binary forms, with or without modification, are permitted provided that the following conditions are met:

1. Redistributions source code must retain the above copyright notice, this list of conditions and the following disclaimer.
2. Redistributions in binary form must reproduce the above copyright notice, this list of conditions and the following disclaimer in the documentation and/or other materials provided with the distribution.
3. Neither the name of Xilinx nor the names of its contributors may be used to endorse or promote products derived from this software without specific prior written permission.

THIS SOFTWARE IS PROVIDED BY THE COPYRIGHT HOLDER AND CONTRIBUTORS "AS IS" AND ANY EXPRESS OR IMPLIED WARRANTIES, INCLUDING, BUT NOT LIMITED TO, THE IMPLIED WARRANTIES OF MERCHANTABILITY AND FITNESS FOR A PARTICULAR PURPOSE ARE DISCLAIMED. IN NO EVENT SHALL THE COPYRIGHT HOLDER OR CONTRIBUTORS BE LIABLE FOR ANY DIRECT, INDIRECT, INCIDENTAL, SPECIAL, EXEMPLARY, OR CONSEQUENTIAL DAMAGES (INCLUDING, BUT NOT LIMITED TO, PROCUREMENT OF SUBSTITUTE GOODS OR SERVICES; LOSS OF USE, DATA, OR PROFITS; OR BUSINESS INTERRUPTION) HOWEVER CAUSED AND ON ANY THEORY OF LIABILITY, WHETHER IN CONTRACT, STRICT LIABILITY, OR TORT (INCLUDING NEGLIGENCE OR OTHERWISE) ARISING IN ANY WAY OUT OF THE USE OF THIS SOFTWARE, EVEN IF ADVISED OF THE POSSIBILITY OF SUCH DAMAGE.

37. Texas Instruments Incorporated (tic6x-*, *-tirtos targets)

Copyright © 1996-2010,2014 Texas Instruments Incorporated

<http://www.ti.com/>

Redistribution and use in source and binary forms, with or without modification, are permitted provided that the following conditions are met:

1. Redistributions of source code must retain the above copyright notice, this list of conditions and the following disclaimer.
2. Redistributions in binary form must reproduce the above copyright notice, this list of conditions and the following disclaimer in the documentation and/or other materials provided with the distribution.
3. Neither the name of Texas Instruments Incorporated nor the names of its contributors may be used to endorse or promote products derived from this software without specific prior written permission.

THIS SOFTWARE IS PROVIDED BY THE COPYRIGHT HOLDERS AND CONTRIBUTORS "AS IS" AND ANY EXPRESS OR IMPLIED WARRANTIES, INCLUDING, BUT NOT LIMITED TO, THE IMPLIED WARRANTIES OF MERCHANTABILITY AND FITNESS FOR A PARTICULAR PURPOSE ARE DISCLAIMED. IN NO EVENT SHALL THE COPYRIGHT OWNER OR CONTRIBUTORS BE LIABLE FOR ANY DIRECT, INDIRECT, INCIDENTAL, SPECIAL, EXEMPLARY, OR CONSEQUENTIAL DAMAGES (INCLUDING, BUT NOT LIMITED TO, PROCUREMENT OF SUBSTITUTE GOODS OR SERVICES; LOSS OF USE, DATA, OR PROFITS; OR BUSINESS INTERRUPTION) HOWEVER CAUSED AND ON ANY THEORY OF LIABILITY, WHETHER IN CONTRACT, STRICT LIABILITY, OR TORT (INCLUDING NEGLIGENCE OR OTHERWISE) ARISING IN ANY WAY OUT OF THE USE OF THIS SOFTWARE, EVEN IF ADVISED OF THE POSSIBILITY OF SUCH DAMAGE.

38. National Semiconductor (cr16-* and crx-* targets)

Copyright (c) 2004 National Semiconductor Corporation

The authors hereby grant permission to use, copy, modify, distribute, and license this software and its documentation for any purpose, provided that existing copyright notices are retained in all copies and that this notice is included verbatim in any distributions. No written agreement, license, or royalty fee is required for any of the authorized uses. Modifications to this software may be copyrighted by their authors and need not follow the licensing terms described here, provided that the new terms are clearly indicated on the first page of each file where they apply.

39. Adapteva, Inc. (epiphany-* targets)

Copyright © 2011, Adapteva, Inc. All rights reserved.

Redistribution and use in source and binary forms, with or without modification, are permitted provided that the following conditions are met:

- Redistributions of source code must retain the above copyright notice, this list of conditions and the following disclaimer.
- Redistributions in binary form must reproduce the above copyright notice, this list of conditions and the following disclaimer in the documentation and/or other materials provided with the distribution.
- Neither the name of Adapteva nor the names of its contributors may be used to endorse or promote products derived from this software without specific prior written permission.

THIS SOFTWARE IS PROVIDED BY THE COPYRIGHT HOLDERS AND CONTRIBUTORS "AS IS" AND ANY EXPRESS OR IMPLIED WARRANTIES, INCLUDING, BUT NOT LIMITED TO, THE IMPLIED WARRANTIES OF MERCHANTABILITY AND FITNESS FOR A PARTICULAR PURPOSE ARE DISCLAIMED. IN NO EVENT SHALL THE COPYRIGHT HOLDER OR CONTRIBUTORS BE LIABLE FOR ANY DIRECT, INDIRECT, INCIDENTAL, SPECIAL, EXEMPLARY, OR CONSEQUENTIAL DAMAGES (INCLUDING, BUT NOT LIMITED TO, PROCUREMENT OF SUBSTITUTE GOODS OR SERVICES; LOSS OF USE, DATA, OR PROFITS; OR BUSINESS INTERRUPTION) HOWEVER CAUSED AND ON ANY THEORY OF LIABILITY, WHETHER IN CONTRACT, STRICT LIABILITY, OR TORT (INCLUDING NEGLIGENCE OR OTHERWISE) ARISING IN ANY WAY OUT OF THE USE OF THIS SOFTWARE, EVEN IF ADVISED OF THE POSSIBILITY OF SUCH DAMAGE.

40. Altera Corporation (nios2-* targets)

Copyright © 2003 Altera Corporation All rights reserved.

Redistribution and use in source and binary forms, with or without modification, are permitted provided that the following conditions are met:

- Redistributions of source code must retain the above copyright notice, this list of conditions and the following disclaimer.

- Redistributions in binary form must reproduce the above copyright notice, this list of conditions and the following disclaimer in the documentation and/or other materials provided with the distribution.
- Neither the name of Altera Corporation nor the names of its contributors may be used to endorse or promote products derived from this software without specific prior written permission.

THIS SOFTWARE IS PROVIDED BY ALTERA CORPORATION, THE COPYRIGHT HOLDER, AND ITS CONTRIBUTORS "AS IS" AND ANY EXPRESS OR IMPLIED WARRANTIES, INCLUDING, BUT NOT LIMITED TO, THE IMPLIED WARRANTIES OF MERCHANTABILITY AND FITNESS FOR A PARTICULAR PURPOSE ARE DISCLAIMED. IN NO EVENT SHALL THE COPYRIGHT HOLDER OR CONTRIBUTORS BE LIABLE FOR ANY DIRECT, INDIRECT, INCIDENTAL, SPECIAL, EXEMPLARY, OR CONSEQUENTIAL DAMAGES (INCLUDING, BUT NOT LIMITED TO, PROCUREMENT OF SUBSTITUTE GOODS OR SERVICES; LOSS OF USE, DATA, OR PROFITS; OR BUSINESS INTERRUPTION) HOWEVER CAUSED AND ON ANY THEORY OF LIABILITY, WHETHER IN CONTRACT, STRICT LIABILITY, OR TORT (INCLUDING NEGLIGENCE OR OTHERWISE) ARISING IN ANY WAY OUT OF THE USE OF THIS SOFTWARE, EVEN IF ADVISED OF THE POSSIBILITY OF SUCH DAMAGE.

41. Ed Schouten - Free BSD

Copyright © 2008 Ed Schouten <ed@FreeBSD.org> All rights reserved.

Redistribution and use in source and binary forms, with or without modification, are permitted provided that the following conditions are met:

1. Redistributions of source code must retain the above copyright notice, this list of conditions and the following disclaimer.
2. Redistributions in binary form must reproduce the above copyright notice, this list of conditions and the following disclaimer in the documentation and/or other materials provided with the distribution.

THIS SOFTWARE IS PROVIDED BY THE AUTHOR AND CONTRIBUTORS ``AS IS'' AND ANY EXPRESS OR IMPLIED WARRANTIES, INCLUDING, BUT NOT LIMITED TO, THE IMPLIED WARRANTIES OF MERCHANTABILITY AND FITNESS FOR A PARTICULAR PURPOSE ARE DISCLAIMED. IN NO EVENT SHALL THE AUTHOR OR CONTRIBUTORS BE LIABLE FOR ANY DIRECT, INDIRECT, INCIDENTAL,

SPECIAL, EXEMPLARY, OR CONSEQUENTIAL DAMAGES (INCLUDING, BUT NOT LIMITED TO, PROCUREMENT OF SUBSTITUTE GOODS OR SERVICES; LOSS OF USE, DATA, OR PROFITS; OR BUSINESS INTERRUPTION) HOWEVER CAUSED AND ON ANY THEORY OF LIABILITY, WHETHER IN CONTRACT, STRICT LIABILITY, OR TORT (INCLUDING NEGLIGENCE OR OTHERWISE) ARISING IN ANY WAY OUT OF THE USE OF THIS SOFTWARE, EVEN IF ADVISED OF THE POSSIBILITY OF SUCH DAMAGE.

II. Xtensa header files

Copyright (c) 2001-2014 Cadence Design Systems, Inc.

Permission is hereby granted, free of charge, to any person obtaining a copy of this software and associated documentation files (the "Software"), to deal in the Software without restriction, including without limitation the rights to use, copy, modify, merge, publish, distribute, sublicense, and/or sell copies of the Software, and to permit persons to whom the Software is furnished to do so, subject to the following conditions:

The above copyright notice and this permission notice shall be included in all copies or substantial portions of the Software.

THE SOFTWARE IS PROVIDED "AS IS", WITHOUT WARRANTY OF ANY KIND, EXPRESS OR IMPLIED, INCLUDING BUT NOT LIMITED TO THE WARRANTIES OF MERCHANTABILITY, FITNESS FOR A PARTICULAR PURPOSE AND NONINFRINGEMENT. IN NO EVENT SHALL THE AUTHORS OR COPYRIGHT HOLDERS BE LIABLE FOR ANY CLAIM, DAMAGES OR OTHER LIABILITY, WHETHER IN AN ACTION OF CONTRACT, TORT OR OTHERWISE, ARISING FROM, OUT OF OR IN CONNECTION WITH THE SOFTWARE OR THE USE OR OTHER DEALINGS IN THE SOFTWARE.

III. Original parts of FreeRTOS

MIT License

Permission is hereby granted, free of charge, to any person obtaining a copy of this software and associated documentation files (the "Software"), to deal in the Software without restriction, including without limitation the rights to use, copy, modify, merge, publish, distribute, sublicense, and/or sell copies of the Software, and to permit persons to

whom the Software is furnished to do so, subject to the following conditions:

The above copyright notice and this permission notice shall be included in all copies or substantial portions of the Software.

THE SOFTWARE IS PROVIDED "AS IS", WITHOUT WARRANTY OF ANY KIND, EXPRESS OR IMPLIED, INCLUDING BUT NOT LIMITED TO THE WARRANTIES OF MERCHANTABILITY, FITNESS FOR A PARTICULAR PURPOSE AND NONINFRINGEMENT. IN NO EVENT SHALL THE AUTHORS OR COPYRIGHT HOLDERS BE LIABLE FOR ANY CLAIM, DAMAGES OR OTHER LIABILITY, WHETHER IN AN ACTION OF CONTRACT, TORT OR OTHERWISE, ARISING FROM, OUT OF OR IN CONNECTION WITH THE SOFTWARE OR THE USE OR OTHER DEALINGS IN THE SOFTWARE.

IV. FatFS library

Copyright © 2018, ChaN, all right reserved.

FatFs module is an open source software. Redistribution and use of FatFs in source and binary forms, with or without modification, are permitted provided that the following condition is met:

1. Redistributions of source code must retain the above copyright notice, this condition and the following disclaimer.

This software is provided by the copyright holder and contributors "AS IS" and any warranties related to this software are DISCLAIMED.

The copyright owner or contributors be NOT LIABLE for any damages caused by use of this software.

V. SPIFFS library

The MIT License (MIT)

Copyright © 2013-2017 Peter Andersson (pelleplutt1976<at>gmail.com)

Permission is hereby granted, free of charge, to any person obtaining a copy of this software and associated documentation files (the "Software"), to deal in the Software without restriction, including without limitation the rights to use, copy, modify, merge, publish, distribute,

sublicense, and/or sell copies of the Software, and to permit persons to whom the Software is furnished to do so, subject to the following conditions:

The above copyright notice and this permission notice shall be included in all copies or substantial portions of the Software.

THE SOFTWARE IS PROVIDED "AS IS", WITHOUT WARRANTY OF ANY KIND, EXPRESS OR IMPLIED, INCLUDING BUT NOT LIMITED TO THE WARRANTIES OF MERCHANTABILITY, FITNESS FOR A PARTICULAR PURPOSE AND NONINFRINGEMENT. IN NO EVENT SHALL THE AUTHORS OR COPYRIGHT HOLDERS BE LIABLE FOR ANY CLAIM, DAMAGES OR OTHER LIABILITY, WHETHER IN AN ACTION OF CONTRACT, TORT OR OTHERWISE, ARISING FROM, OUT OF OR IN CONNECTION WITH THE SOFTWARE OR THE USE OR OTHER DEALINGS IN THE SOFTWARE.

VI. TLSF allocator Two Level Segregated Fit memory allocator

Copyright © 2006-2016, Matthew Conte All rights reserved.

Redistribution and use in source and binary forms, with or without modification, are permitted provided that the following conditions are met:

- Redistributions of source code must retain the above copyright notice, this list of conditions and the following disclaimer.
- Redistributions in binary form must reproduce the above copyright notice, this list of conditions and the following disclaimer in the documentation and/or other materials provided with the distribution.
- Neither the name of the copyright holder nor the names of its contributors may be used to endorse or promote products derived from this software without specific prior written permission.

THIS SOFTWARE IS PROVIDED BY THE COPYRIGHT HOLDERS AND CONTRIBUTORS "AS IS" AND ANY EXPRESS OR IMPLIED WARRANTIES, INCLUDING, BUT NOT LIMITED TO, THE IMPLIED WARRANTIES OF MERCHANTABILITY AND FITNESS FOR A PARTICULAR PURPOSE ARE DISCLAIMED. IN NO EVENT SHALL MATTHEW CONTE BE LIABLE FOR ANY DIRECT, INDIRECT, INCIDENTAL, SPECIAL, EXEMPLARY, OR CONSEQUENTIAL DAMAGES (INCLUDING, BUT NOT LIMITED TO, PROCUREMENT OF SUBSTITUTE GOODS OR

SERVICES; LOSS OF USE, DATA, OR PROFITS; OR BUSINESS INTERRUPTION) HOWEVER CAUSED AND ON ANY THEORY OF LIABILITY, WHETHER IN CONTRACT, STRICT LIABILITY, OR TORT (INCLUDING NEGLIGENCE OR OTHERWISE) ARISING IN ANY WAY OUT OF THE USE OF THIS SOFTWARE, EVEN IF ADVISED OF THE POSSIBILITY OF SUCH DAMAGE.

VII. HTTP Parser Based on src/http/nginx_http_parse.c

Based on src/http/nginx_http_parse.c from NGINX copyright Igor Sysoev

Additional changes are licensed under the same terms as NGINX and copyright Joyent, Inc. and other Node contributors. All rights reserved.

Permission is hereby granted, free of charge, to any person obtaining a copy of this software and associated documentation files (the "Software"), to deal in the Software without restriction, including without limitation the rights to use, copy, modify, merge, publish, distribute, sublicense, and/or sell copies of the Software, and to permit persons to whom the Software is furnished to do so, subject to the following conditions:

The above copyright notice and this permission notice shall be included in all copies or substantial portions of the Software.

THE SOFTWARE IS PROVIDED "AS IS", WITHOUT WARRANTY OF ANY KIND, EXPRESS OR IMPLIED, INCLUDING BUT NOT LIMITED TO THE WARRANTIES OF MERCHANTABILITY, FITNESS FOR A PARTICULAR PURPOSE AND NONINFRINGEMENT. IN NO EVENT SHALL THE AUTHORS OR COPYRIGHT HOLDERS BE LIABLE FOR ANY CLAIM, DAMAGES OR OTHER LIABILITY, WHETHER IN AN ACTION OF CONTRACT, TORT OR OTHERWISE, ARISING FROM, OUT OF OR IN CONNECTION WITH THE SOFTWARE OR THE USE OR OTHER DEALINGS IN THE SOFTWARE.

VIII. miniz

Copyright 2013-2014 RAD Game Tools and Valve Software

Copyright 2010-2014 Rich Geldreich and Tenacious Software LLC

All Rights Reserved.

Permission is hereby granted, free of charge, to any person obtaining a copy of this software and associated documentation files (the "Software"), to deal in the Software without restriction, including without limitation the rights to use, copy, modify, merge, publish, distribute, sublicense, and/or sell copies of the Software, and to permit persons to whom the Software is furnished to do so, subject to the following conditions:

The above copyright notice and this permission notice shall be included in all copies or substantial portions of the Software.

THE SOFTWARE IS PROVIDED "AS IS", WITHOUT WARRANTY OF ANY KIND, EXPRESS OR IMPLIED, INCLUDING BUT NOT LIMITED TO THE WARRANTIES OF MERCHANTABILITY, FITNESS FOR A PARTICULAR PURPOSE AND NONINFRINGEMENT. IN NO EVENT SHALL THE AUTHORS OR COPYRIGHT HOLDERS BE LIABLE FOR ANY CLAIM, DAMAGES OR OTHER LIABILITY, WHETHER IN AN ACTION OF CONTRACT, TORT OR OTHERWISE, ARISING FROM, OUT OF OR IN CONNECTION WITH THE SOFTWARE OR THE USE OR OTHER DEALINGS IN THE SOFTWARE.

IX. tinyuf2

Copyright (c) 2020 Ha Thach

Permission is hereby granted, free of charge, to any person obtaining a copy of this software and associated documentation files (the "Software"), to deal in the Software without restriction, including without limitation the rights to use, copy, modify, merge, publish, distribute, sublicense, and/or sell copies of the Software, and to permit persons to whom the Software is furnished to do so, subject to the following conditions:

The above copyright notice and this permission notice shall be included in all copies or substantial portions of the Software.

THE SOFTWARE IS PROVIDED "AS IS", WITHOUT WARRANTY OF ANY KIND, EXPRESS OR IMPLIED, INCLUDING BUT NOT LIMITED TO THE WARRANTIES OF MERCHANTABILITY, FITNESS FOR A PARTICULAR PURPOSE AND NONINFRINGEMENT. IN NO EVENT SHALL THE AUTHORS OR COPYRIGHT HOLDERS BE LIABLE FOR ANY CLAIM, DAMAGES OR OTHER LIABILITY, WHETHER IN AN

ACTION OF CONTRACT, TORT OR OTHERWISE, ARISING FROM, OUT OF OR IN CONNECTION WITH THE SOFTWARE OR THE USE OR OTHER DEALINGS IN THE SOFTWARE.

X. cJSON

Copyright (c) 2009-2017 Dave Gamble and cJSON contributors

Permission is hereby granted, free of charge, to any person obtaining a copy of this software and associated documentation files (the "Software"), to deal in the Software without restriction, including without limitation the rights to use, copy, modify, merge, publish, distribute, sublicense, and/or sell copies of the Software, and to permit persons to whom the Software is furnished to do so, subject to the following conditions:

The above copyright notice and this permission notice shall be included in all copies or substantial portions of the Software.

THE SOFTWARE IS PROVIDED "AS IS", WITHOUT WARRANTY OF ANY KIND, EXPRESS OR IMPLIED, INCLUDING BUT NOT LIMITED TO THE WARRANTIES OF MERCHANTABILITY, FITNESS FOR A PARTICULAR PURPOSE AND NONINFRINGEMENT. IN NO EVENT SHALL THE AUTHORS OR COPYRIGHT HOLDERS BE LIABLE FOR ANY CLAIM, DAMAGES OR OTHER LIABILITY, WHETHER IN AN ACTION OF CONTRACT, TORT OR OTHERWISE, ARISING FROM, OUT OF OR IN CONNECTION WITH THE SOFTWARE OR THE USE OR OTHER DEALINGS IN THE SOFTWARE.

XI. Xtensa libhal

Copyright (c) 2003, 2006, 2010 Tensilica Inc.

Permission is hereby granted, free of charge, to any person obtaining a copy of this software and associated documentation files (the "Software"), to deal in the Software without restriction, including without limitation the rights to use, copy, modify, merge, publish, distribute, sublicense, and/or sell copies of the Software, and to permit persons to whom the Software is furnished to do so, subject to the following conditions:

The above copyright notice and this permission notice shall be included in all copies or substantial portions of the Software.

THE SOFTWARE IS PROVIDED "AS IS", WITHOUT WARRANTY OF ANY KIND, EXPRESS OR IMPLIED, INCLUDING BUT NOT LIMITED TO THE WARRANTIES OF MERCHANTABILITY, FITNESS FOR A PARTICULAR PURPOSE AND NONINFRINGEMENT. IN NO EVENT SHALL THE AUTHORS OR COPYRIGHT HOLDERS BE LIABLE FOR ANY CLAIM, DAMAGES OR OTHER LIABILITY, WHETHER IN AN ACTION OF CONTRACT, TORT OR OTHERWISE, ARISING FROM, OUT OF OR IN CONNECTION WITH THE SOFTWARE OR THE USE OR OTHER DEALINGS IN THE SOFTWARE.

XII. TinyBasic Plus

Copyright (c) 2012-2013

Permission is hereby granted, free of charge, to any person obtaining a copy of this software and associated documentation files (the "Software"), to deal in the Software without restriction, including without limitation the rights to use, copy, modify, merge, publish, distribute, sublicense, and/or sell copies of the Software, and to permit persons to whom the Software is furnished to do so, subject to the following conditions:

The above copyright notice and this permission notice shall be included in all copies or substantial portions of the Software.

THE SOFTWARE IS PROVIDED "AS IS", WITHOUT WARRANTY OF ANY KIND, EXPRESS OR IMPLIED, INCLUDING BUT NOT LIMITED TO THE WARRANTIES OF MERCHANTABILITY, FITNESS FOR A PARTICULAR PURPOSE AND NONINFRINGEMENT. IN NO EVENT SHALL THE AUTHORS OR COPYRIGHT HOLDERS BE LIABLE FOR ANY CLAIM, DAMAGES OR OTHER LIABILITY, WHETHER IN AN ACTION OF CONTRACT, TORT OR OTHERWISE, ARISING FROM, OUT OF OR IN CONNECTION WITH THE SOFTWARE OR THE USE OR OTHER DEALINGS IN THE SOFTWARE.

XIII. wpa_suppliant

Copyright (c) 2003-2022, Jouni Malinen <j@w1.fi> and contributors

All Rights Reserved.

This software may be distributed, used, and modified under the terms of BSD license:

Redistribution and use in source and binary forms, with or without modification, are permitted provided that the following conditions are met:

1. Redistributions of source code must retain the above copyright notice, this list of conditions and the following disclaimer.
2. Redistributions in binary form must reproduce the above copyright notice, this list of conditions and the following disclaimer in the documentation and/or other materials provided with the distribution.
3. Neither the name(s) of the above-listed copyright holder(s) nor the names of its contributors may be used to endorse or promote products derived from this software without specific prior written permission.

THIS SOFTWARE IS PROVIDED BY THE COPYRIGHT HOLDERS AND CONTRIBUTORS "AS IS" AND ANY EXPRESS OR IMPLIED WARRANTIES, INCLUDING, BUT NOT LIMITED TO, THE IMPLIED WARRANTIES OF MERCHANTABILITY AND FITNESS FOR A PARTICULAR PURPOSE ARE DISCLAIMED. IN NO EVENT SHALL THE COPYRIGHT OWNER OR CONTRIBUTORS BE LIABLE FOR ANY DIRECT, INDIRECT, INCIDENTAL, SPECIAL, EXEMPLARY, OR CONSEQUENTIAL DAMAGES (INCLUDING, BUT NOT LIMITED TO, PROCUREMENT OF SUBSTITUTE GOODS OR SERVICES; LOSS OF USE, DATA, OR PROFITS; OR BUSINESS INTERRUPTION) HOWEVER CAUSED AND ON ANY THEORY OF LIABILITY, WHETHER IN CONTRACT, STRICT LIABILITY, OR TORT (INCLUDING NEGLIGENCE OR OTHERWISE) ARISING IN ANY WAY OUT OF THE USE OF THIS SOFTWARE, EVEN IF ADVISED OF THE POSSIBILITY OF SUCH DAMAGE.

XIV. TjpgDec

Copyright (C) 2011, ChaN, all right reserved.

The TjpgDec module is a free software and there is NO WARRANTY.

No restriction on use. You can use, modify and redistribute it for personal, non-profit or commercial products UNDER YOUR RESPONSIBILITY.

Redistributions of source code must retain the above copyright notice.

XV. tinyusb

Copyright (c) 2018, hathach (tinyusb.org)

Permission is hereby granted, free of charge, to any person obtaining a copy of this software and associated documentation files (the "Software"), to deal in the Software without restriction, including without limitation the rights to use, copy, modify, merge, publish, distribute, sublicense, and/or sell copies of the Software, and to permit persons to whom the Software is furnished to do so, subject to the following conditions:

The above copyright notice and this permission notice shall be included in all copies or substantial portions of the Software.

THE SOFTWARE IS PROVIDED "AS IS", WITHOUT WARRANTY OF ANY KIND, EXPRESS OR IMPLIED, INCLUDING BUT NOT LIMITED TO THE WARRANTIES OF MERCHANTABILITY, FITNESS FOR A PARTICULAR PURPOSE AND NONINFRINGEMENT. IN NO EVENT SHALL THE AUTHORS OR COPYRIGHT HOLDERS BE LIABLE FOR ANY CLAIM, DAMAGES OR OTHER LIABILITY, WHETHER IN AN ACTION OF CONTRACT, TORT OR OTHERWISE, ARISING FROM, OUT OF OR IN CONNECTION WITH THE SOFTWARE OR THE USE OR OTHER DEALINGS IN THE SOFTWARE.

INFORMATION AND COMMENTS IN RELATION TO THE OPEN SOURCE COMPONENTS USED IN THE CONFIGURATION SOFTWARE

The following list contains all Open Source components used in this application. The document includes the licence agreements under which the software is allowed to be used as well as any existing copyright notices.

This application contains the following Open Source Software components:

INFORMATION AND COMMENTS IN RELATION TO THE OPEN SOURCE

COMPONENTS USED IN THE CONFIGURATION SOFTWARE	35
I. PdfSharp.Xps.dotNet.Core.....	35
II. Newtonsoft.Json.....	36
III. NETStandard.Library.....	36
IV. Microsoft.CSharp	37
V. .NET	38
VI. NAudio	39
VII. Microsoft.Web.WebView2	40
VIII. Font "Poppins"	41
IX. HttpMachine	43
X. Sources from the main developer of this application.....	45

The following information details the relevant licence text for each Open Source software component:

I. PdfSharp.Xps.dotNet.Core

MIT License

Copyright (c) 2005-2018 empira Software GmbH, Troisdorf (Germany)

Permission is hereby granted, free of charge, to any person obtaining a copy of this software and associated documentation files (the "Software"), to deal in the Software without restriction, including without limitation the rights to use, copy, modify, merge, publish, distribute, sublicense, and/or sell copies of the Software, and to permit persons to whom the Software is furnished to do so, subject to the following conditions:

The above copyright notice and this permission notice shall be included in all copies or substantial portions of the Software.

THE SOFTWARE IS PROVIDED "AS IS", WITHOUT WARRANTY OF ANY KIND, EXPRESS OR IMPLIED, INCLUDING BUT NOT LIMITED TO THE WARRANTIES OF MERCHANTABILITY, FITNESS FOR A PARTICULAR PURPOSE AND NONINFRINGEMENT. IN NO EVENT SHALL THE AUTHORS OR COPYRIGHT HOLDERS BE LIABLE FOR ANY CLAIM, DAMAGES OR OTHER LIABILITY, WHETHER IN AN ACTION OF CONTRACT, TORT OR OTHERWISE, ARISING FROM, OUT OF OR IN CONNECTION WITH THE SOFTWARE OR THE USE OR OTHER DEALINGS IN THE SOFTWARE.

II. Newtonsoft.Json

The MIT License (MIT)

Copyright (c) 2007 James Newton-King

Permission is hereby granted, free of charge, to any person obtaining a copy of this software and associated documentation files (the "Software"), to deal in the Software without restriction, including without limitation the rights to use, copy, modify, merge, publish, distribute, sublicense, and/or sell copies of the Software, and to permit persons to whom the Software is furnished to do so, subject to the following conditions:

The above copyright notice and this permission notice shall be included in all copies or substantial portions of the Software.

THE SOFTWARE IS PROVIDED "AS IS", WITHOUT WARRANTY OF ANY KIND, EXPRESS OR IMPLIED, INCLUDING BUT NOT LIMITED TO THE WARRANTIES OF MERCHANTABILITY, FITNESS FOR A PARTICULAR PURPOSE AND NONINFRINGEMENT. IN NO EVENT SHALL THE AUTHORS OR COPYRIGHT HOLDERS BE LIABLE FOR ANY CLAIM, DAMAGES OR OTHER LIABILITY, WHETHER IN AN ACTION OF CONTRACT, TORT OR OTHERWISE, ARISING FROM, OUT OF OR IN CONNECTION WITH THE SOFTWARE OR THE USE OR OTHER DEALINGS IN THE SOFTWARE.

III. NETStandard.Library

The MIT License (MIT)

Copyright (c) .NET Foundation and Contributors

All rights reserved.

Permission is hereby granted, free of charge, to any person obtaining a copy of this software and associated documentation files (the "Software"), to deal in the Software without restriction, including without limitation the rights to use, copy, modify, merge, publish, distribute, sublicense, and/or sell copies of the Software, and to permit persons to whom the Software is furnished to do so, subject to the following conditions:

The above copyright notice and this permission notice shall be included in all copies or substantial portions of the Software.

THE SOFTWARE IS PROVIDED "AS IS", WITHOUT WARRANTY OF ANY KIND, EXPRESS OR IMPLIED, INCLUDING BUT NOT LIMITED TO THE WARRANTIES OF MERCHANTABILITY, FITNESS FOR A PARTICULAR PURPOSE AND NONINFRINGEMENT. IN NO EVENT SHALL THE AUTHORS OR COPYRIGHT HOLDERS BE LIABLE FOR ANY CLAIM, DAMAGES OR OTHER LIABILITY, WHETHER IN AN ACTION OF CONTRACT, TORT OR OTHERWISE, ARISING FROM, OUT OF OR IN CONNECTION WITH THE SOFTWARE OR THE USE OR OTHER DEALINGS IN THE SOFTWARE.

THE SOFTWARE IS PROVIDED "AS IS", WITHOUT WARRANTY OF ANY KIND, EXPRESS OR IMPLIED, INCLUDING BUT NOT LIMITED TO THE WARRANTIES OF MERCHANTABILITY, FITNESS FOR A PARTICULAR PURPOSE AND NONINFRINGEMENT. IN NO EVENT SHALL THE AUTHORS OR COPYRIGHT HOLDERS BE LIABLE FOR ANY CLAIM, DAMAGES OR OTHER LIABILITY, WHETHER IN AN ACTION OF CONTRACT, TORT OR OTHERWISE, ARISING FROM, OUT OF OR IN CONNECTION WITH THE SOFTWARE OR THE USE OR OTHER DEALINGS IN THE SOFTWARE.

IV. Microsoft.CSharp

The MIT License (MIT)

Copyright (c) .NET Foundation and Contributors

All rights reserved.

Permission is hereby granted, free of charge, to any person obtaining a copy of this software and associated documentation files (the

"Software"), to deal in the Software without restriction, including without limitation the rights to use, copy, modify, merge, publish, distribute, sublicense, and/or sell copies of the Software, and to permit persons to whom the Software is furnished to do so, subject to the following conditions:

The above copyright notice and this permission notice shall be included in all copies or substantial portions of the Software.

THE SOFTWARE IS PROVIDED "AS IS", WITHOUT WARRANTY OF ANY KIND, EXPRESS OR IMPLIED, INCLUDING BUT NOT LIMITED TO THE WARRANTIES OF MERCHANTABILITY, FITNESS FOR A PARTICULAR PURPOSE AND NONINFRINGEMENT. IN NO EVENT SHALL THE AUTHORS OR COPYRIGHT HOLDERS BE LIABLE FOR ANY CLAIM, DAMAGES OR OTHER LIABILITY, WHETHER IN AN ACTION OF CONTRACT, TORT OR OTHERWISE, ARISING FROM, OUT OF OR IN CONNECTION WITH THE SOFTWARE OR THE USE OR OTHER DEALINGS IN THE SOFTWARE. THE SOFTWARE IS PROVIDED "AS IS", WITHOUT WARRANTY OF ANY KIND, EXPRESS OR IMPLIED, INCLUDING BUT NOT LIMITED TO THE WARRANTIES OF MERCHANTABILITY, FITNESS FOR A PARTICULAR PURPOSE AND NONINFRINGEMENT. IN NO EVENT SHALL THE AUTHORS OR COPYRIGHT HOLDERS BE LIABLE FOR ANY CLAIM, DAMAGES OR OTHER LIABILITY, WHETHER IN AN ACTION OF CONTRACT, TORT OR OTHERWISE, ARISING FROM, OUT OF OR IN CONNECTION WITH THE SOFTWARE OR THE USE OR OTHER DEALINGS IN THE SOFTWARE.

V. .NET

The MIT License (MIT)

Copyright (c) .NET Foundation and Contributors

All rights reserved.

Permission is hereby granted, free of charge, to any person obtaining a copy of this software and associated documentation files (the "Software"), to deal in the Software without restriction, including without limitation the rights to use, copy, modify, merge, publish, distribute, sublicense, and/or sell copies of the Software, and to permit persons to whom the Software is furnished to do so, subject to the following conditions:

The above copyright notice and this permission notice shall be included in all copies or substantial portions of the Software.

THE SOFTWARE IS PROVIDED "AS IS", WITHOUT WARRANTY OF ANY KIND, EXPRESS OR IMPLIED, INCLUDING BUT NOT LIMITED TO THE WARRANTIES OF MERCHANTABILITY, FITNESS FOR A PARTICULAR PURPOSE AND NON-INFRINGEMENT. IN NO EVENT SHALL THE AUTHORS OR COPYRIGHT HOLDERS BE LIABLE FOR ANY CLAIM, DAMAGES OR OTHER LIABILITY, WHETHER IN AN ACTION OF CONTRACT, TORT OR OTHERWISE, ARISING FROM, OUT OF OR IN CONNECTION WITH THE SOFTWARE OR THE USE OR OTHER DEALINGS IN THE SOFTWARE.

THE SOFTWARE IS PROVIDED "AS IS", WITHOUT WARRANTY OF ANY KIND, EXPRESS OR IMPLIED, INCLUDING BUT NOT LIMITED TO THE WARRANTIES OF MERCHANTABILITY, FITNESS FOR A PARTICULAR PURPOSE AND NON-INFRINGEMENT. IN NO EVENT SHALL THE AUTHORS OR COPYRIGHT HOLDERS BE LIABLE FOR ANY CLAIM, DAMAGES OR OTHER LIABILITY, WHETHER IN AN ACTION OF CONTRACT, TORT OR OTHERWISE, ARISING FROM, OUT OF OR IN CONNECTION WITH THE SOFTWARE OR THE USE OR OTHER DEALINGS IN THE SOFTWARE.

VI. NAudio

Copyright 2020 Mark Heath

Permission is hereby granted, free of charge, to any person obtaining a copy of this software and associated documentation files (the "Software"), to deal in the Software without restriction, including without limitation the rights to use, copy, modify, merge, publish, distribute, sublicense, and/or sell copies of the Software, and to permit persons to whom the Software is furnished to do so, subject to the following conditions:

The above copyright notice and this permission notice shall be included in all copies or substantial portions of the Software.

THE SOFTWARE IS PROVIDED "AS IS", WITHOUT WARRANTY OF ANY KIND, EXPRESS OR IMPLIED, INCLUDING BUT NOT LIMITED TO THE WARRANTIES OF MERCHANTABILITY, FITNESS FOR A PARTICULAR PURPOSE AND NON-INFRINGEMENT. IN NO EVENT SHALL THE AUTHORS OR COPYRIGHT HOLDERS

BE LIABLE FOR ANY CLAIM, DAMAGES OR OTHER LIABILITY, WHETHER IN AN ACTION OF CONTRACT, TORT OR OTHERWISE, ARISING FROM, OUT OF OR IN CONNECTION WITH THE SOFTWARE OR THE USE OR OTHER DEALINGS IN THE SOFTWARE.

VII. Microsoft.Web.WebView2

Copyright (C) Microsoft Corporation. All rights reserved.

Redistribution and use in source and binary forms, with or without modification, are permitted provided that the following conditions are met:

- * Redistributions of source code must retain the above copyright notice, this list of conditions and the following disclaimer.

- * Redistributions in binary form must reproduce the above copyright notice, this list of conditions and the following disclaimer in the documentation and/or other materials provided with the distribution.

- * The name of Microsoft Corporation, or the names of its contributors may not be used to endorse or promote products derived from this software without specific prior written permission.

THIS SOFTWARE IS PROVIDED BY THE COPYRIGHT HOLDERS AND CONTRIBUTORS "AS IS" AND ANY EXPRESS OR IMPLIED WARRANTIES, INCLUDING, BUT NOT LIMITED TO, THE IMPLIED WARRANTIES OF MERCHANTABILITY AND FITNESS FOR A PARTICULAR PURPOSE ARE DISCLAIMED. IN NO EVENT SHALL THE COPYRIGHT OWNER OR CONTRIBUTORS BE LIABLE FOR ANY DIRECT, INDIRECT, INCIDENTAL, SPECIAL, EXEMPLARY, OR CONSEQUENTIAL DAMAGES (INCLUDING, BUT NOT LIMITED TO, PROCUREMENT OF SUBSTITUTE GOODS OR SERVICES; LOSS OF USE, DATA, OR PROFITS; OR BUSINESS INTERRUPTION) HOWEVER CAUSED AND ON ANY THEORY OF LIABILITY, WHETHER IN CONTRACT, STRICT LIABILITY, OR TORT (INCLUDING NEGLIGENCE OR OTHERWISE) ARISING IN ANY WAY OUT OF THE USE OF THIS SOFTWARE, EVEN IF ADVISED OF THE POSSIBILITY OF SUCH DAMAGE. THE SOFTWARE IS PROVIDED "AS IS", WITHOUT WARRANTY OF ANY KIND, EXPRESS OR IMPLIED, INCLUDING BUT NOT LIMITED TO THE WARRANTIES OF MERCHANTABILITY, FITNESS FOR A PARTICULAR PURPOSE AND NONINFRINGEMENT. IN NO EVENT SHALL THE AUTHORS OR COPYRIGHT HOLDERS

BE LIABLE FOR ANY CLAIM, DAMAGES OR OTHER LIABILITY, WHETHER IN AN ACTION OF CONTRACT, TORT OR OTHERWISE, ARISING FROM, OUT OF OR IN CONNECTION WITH THE SOFTWARE OR THE USE OR OTHER DEALINGS IN THE SOFTWARE.

VIII. Font “Poppins”

Copyright 2014-2019 Indian Type Foundry (info@indiantypefoundry.com)

This Font Software is licensed under the SIL Open Font License, Version 1.1.

This license is copied below, and is also available with a FAQ at:

<http://scripts.sil.org/OFL>

SIL OPEN FONT LICENSE Version 1.1 - 26 February 2007

PREAMBLE

The goals of the Open Font License (OFL) are to stimulate worldwide development of collaborative font projects, to support the font creation efforts of academic and linguistic communities, and to provide a free and open framework in which fonts may be shared and improved in partnership with others.

The OFL allows the licensed fonts to be used, studied, modified and redistributed freely as long as they are not sold by themselves. The fonts, including any derivative works, can be bundled, embedded, redistributed and/or sold with any software provided that any reserved names are not used by derivative works. The fonts and derivatives, however, cannot be released under any other type of license. The requirement for fonts to remain under this license does not apply to any document created using the fonts or their derivatives.

DEFINITIONS

"Font Software" refers to the set of files released by the Copyright Holder(s) under this license and clearly marked as such. This may include source files, build scripts and documentation.

"Reserved Font Name" refers to any names specified as such after the copyright statement(s).

"Original Version" refers to the collection of Font Software components as distributed by the Copyright Holder(s).

"Modified Version" refers to any derivative made by adding to, deleting, or substituting -- in part or in whole -- any of the components of the Original Version, by changing formats or by porting the Font Software to a new environment.

"Author" refers to any designer, engineer, programmer, technical writer or other person who contributed to the Font Software.

PERMISSION & CONDITIONS

Permission is hereby granted, free of charge, to any person obtaining a copy of the Font Software, to use, study, copy, merge, embed, modify, redistribute, and sell modified and unmodified copies of the Font Software, subject to the following conditions:

- 1) Neither the Font Software nor any of its individual components, in Original or Modified Versions, may be sold by itself.
- 2) Original or Modified Versions of the Font Software may be bundled, redistributed and/or sold with any software, provided that each copy contains the above copyright notice and this license. These can be included either as stand-alone text files, human-readable headers or in the appropriate machine-readable metadata fields within text or binary files as long as those fields can be easily viewed by the user.
- 3) No Modified Version of the Font Software may use the Reserved Font Name(s) unless explicit written permission is granted by the corresponding Copyright Holder. This restriction only applies to the primary font name as presented to the users.

4) The name(s) of the Copyright Holder(s) or the Author(s) of the Font Software shall not be used to promote, endorse or advertise any Modified Version, except to acknowledge the contribution(s) of the Copyright Holder(s) and the Author(s) or with their explicit written permission.

5) The Font Software, modified or unmodified, in part or in whole, must be distributed entirely under this license, and must not be distributed under any other license. The requirement for fonts to remain under this license does not apply to any document created using the Font Software.

TERMINATION

This license becomes null and void if any of the above conditions are not met.

DISCLAIMER

THE FONT SOFTWARE IS PROVIDED "AS IS", WITHOUT WARRANTY OF ANY KIND, EXPRESS OR IMPLIED, INCLUDING BUT NOT LIMITED TO ANY WARRANTIES OF MERCHANTABILITY, FITNESS FOR A PARTICULAR PURPOSE AND NONINFRINGEMENT OF COPYRIGHT, PATENT, TRADEMARK, OR OTHER RIGHT. IN NO EVENT SHALL THE COPYRIGHT HOLDER BE LIABLE FOR ANY CLAIM, DAMAGES OR OTHER LIABILITY, INCLUDING ANY GENERAL, SPECIAL, INDIRECT, INCIDENTAL, OR CONSEQUENTIAL DAMAGES, WHETHER IN AN ACTION OF CONTRACT, TORT OR OTHERWISE, ARISING FROM, OUT OF THE USE OR INABILITY TO USE THE FONT SOFTWARE OR FROM OTHER DEALINGS IN THE FONT SOFTWARE.

IX. HttpMachine

HttpMachine - Copyright (c) 2011 Benjamin van der Veen

Permission is hereby granted, free of charge, to any person obtaining a copy of this software and associated documentation files (the "Software"), to deal in the Software without restriction, including without limitation the rights to use, copy, modify, merge, publish, distribute, sublicense, and/or sell copies of the Software, and to permit persons to whom the Software is furnished to do so, subject to the following conditions:

The above copyright notice and this permission notice shall be included in all copies or substantial portions of the Software.

THE SOFTWARE IS PROVIDED "AS IS", WITHOUT WARRANTY OF ANY KIND, EXPRESS OR IMPLIED, INCLUDING BUT NOT LIMITED TO THE WARRANTIES OF MERCHANTABILITY, FITNESS FOR A PARTICULAR PURPOSE AND NONINFRINGEMENT. IN NO EVENT SHALL THE AUTHORS OR COPYRIGHT HOLDERS BE LIABLE FOR ANY CLAIM, DAMAGES OR OTHER LIABILITY, WHETHER IN AN ACTION OF CONTRACT, TORT OR OTHERWISE, ARISING FROM, OUT OF OR IN CONNECTION WITH THE SOFTWARE OR THE USE OR OTHER DEALINGS IN THE SOFTWARE.

X. Sources from the main developer of this application

Copyright (c) 2022 Bett Ingenieure GmbH

Copyright (c) 2022 Fabian Bett

Permission is hereby granted, free of charge, to any person obtaining a copy of this software and associated documentation files (the "Software"), to deal in the Software without restriction, including without limitation the rights to use, copy, modify, merge, publish, distribute, sublicense, and/or sell copies of the Software, and to permit persons to whom the Software is furnished to do so, subject to the following conditions:

The above copyright notice and this permission notice shall be included in all copies or substantial portions of the Software.

THE SOFTWARE IS PROVIDED "AS IS", WITHOUT WARRANTY OF ANY KIND, EXPRESS OR IMPLIED, INCLUDING BUT NOT LIMITED TO THE WARRANTIES OF MERCHANTABILITY, FITNESS FOR A PARTICULAR PURPOSE AND NONINFRINGEMENT. IN NO EVENT SHALL THE AUTHORS OR COPYRIGHT HOLDERS BE LIABLE FOR ANY CLAIM, DAMAGES OR OTHER LIABILITY, WHETHER IN AN ACTION OF CONTRACT, TORT OR OTHERWISE, ARISING FROM, OUT OF OR IN CONNECTION WITH THE SOFTWARE OR THE USE OR OTHER DEALINGS IN THE SOFTWARE.