

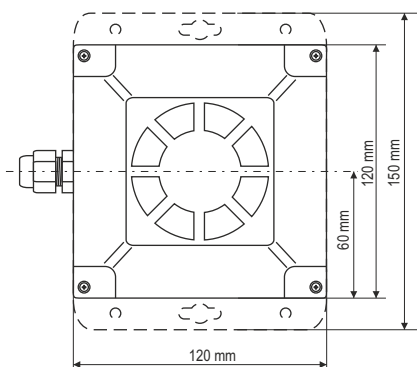

Rozmerový výkres

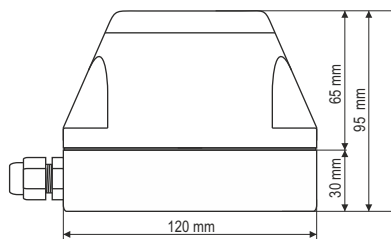
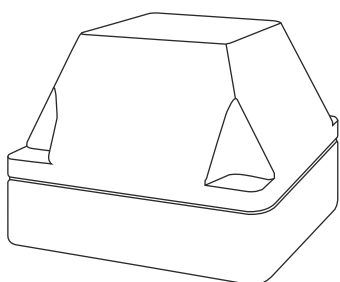

Kombinovaná optická a akustická signalizácia A-MLOAS.

Opticko-akustická signalizácia s 2 spôsobmi montáže. LED technológia svetelnej signalizácie A-MLOAS s extra silnými svetelnými výbojmi (nastavenie až 21 svetelných efektov) s vysokou energiou určená ako výstražná svetelná signalizácia. Intenzívny záblesk vyvoláva následné reflexie na okolitých plochách čím sa zväčšuje účinnosť signalizácie. Robustná konštrukcia, vysoký stupeň krytia ju predurčujú k použitiu v náročných priemyselných prevádzkach.

- nastavenie až 21 svetelných efektov
- 32 tónov zvukovej signalizácie
- možnosť nastavenie hlasitosti 5 dB až 115 dB
- možnosť vzdialene vypnúť zvukovú signalizáciu
- možnosť vzdialene prepnúť nastavený tón na extra tón

Objednávacie špecifikácie s úchytmi "A"

A-MLOAS.24.A.4	24V / oranžová
A-MLOAS.24.A.5	24V / červená
A-MLOAS.24.A.2	24V / zelená
A-MLOAS.230.A.4	230V / oranžová
A-MLOAS.230.A.5	230V / červená
A-MLOAS.230.A.2	230V / zelená

Objednávacie špecifikácie bez úchyty "B"

A-MLOAS.24.B.4	24V / oranžová
A-MLOAS.24.B.5	24V / červená
A-MLOAS.24.B.2	24V / zelená
A-MLOAS.230.B.4	230V / oranžová
A-MLOAS.230.B.5	230V / červená
A-MLOAS.230.B.2	230V / zelená

Technické parametre

Napájacie napätie	24V AC/DC 230V AC, 50 Hz
Počet svetelných efektov	21
Počet akustických tónov	32
Materiál základne	PC / RAL 7035 svetlo šedá
Materiál krytky	PC
Farby krytie	červená, oranžová, zelená
Krytie	IP 65
Rozsah prac. teplôt	-30 až + 50°C
Priemer prívod. kábla	4 – 8 mm
Rozmery s úchytmi	150 x 120 x 95 mm
Rozmery bez úchyty	120 x 120 x 95 mm
Akustický výkon	5 - 115 dB

Farby krytie:

































































- 2 - zelená
- 3 - modrá (na vyžiadanie)
- 4 - oranžová
- 5 - červená

























































Nastavenie aktivácie húkačky a majáka

Nastavenie DIP prepínača	Húkačka	Maják
	OFF	OFF
	ON	OFF
	OFF	ON
	ON	ON

Nastavenie DIP prepínača (húkačka)

	Poloha prepínača	Druh tónu		Frekvencia tónu kHz	Modulácia ton1; ton2
A01		staly ton		2,34kHz	
A02		kizavy ton		800 - 990 Hz	
A03		kizavy ton		787 - 950 Hz	
A04		staly ton		2,77kHz	
A05		kizavy ton		2,36 - 2,67 kHz	
A06		kizavy ton		2,36 - 2,75 kHz	
A07		kizavy ton		521 - 1190 Hz	
A08		kizavy ton		578 - 1150 Hz	
A09		dvojton		2,35 / 2,76 kHz	0,25s ; 0,25s
A10		singl pulz ton		961 Hz	1s ; 1s
A11		dvojton		787Hz , 952 Hz	0,5s ; 0,5s
A12		singl pulz ton		2,78kHz	1s ; 1s
A13		singl pulz ton		961Hz	0,256s ; 1s
A14		staly ton		961 Hz	
A15		dvojton		555Hz, 438Hz	0,5s ; 0,5s
A16		singl pulz ton		653Hz	0,15s; 0,15s
A17		singl pulz ton		653Hz	1,82s ; 1,82s
A18		singl pulz ton		653Hz	6,3s ; 13s
A19		staly ton		653Hz	
A20		dvojton		549Hz , 438Hz	1s ; 1s
A21		singl pulz ton		653Hz	0,5s ; 0,5s
A22		singl pulz ton		2,76kHz	0,15s
A23		sing pulz ton		2,76kHz	0,15s ; 0,1s
A24		kizavy ton		2,37kHz	
A25		tri pulzy		958 Hz	0,5s; 0,5s ; 2s
A26		tri pulzy		2,76kHz	0,5s; 0,5s ; 2s
A27		staly ton		3,82kHz	
A28		kizavy ton		1,98kHz - 2,6kHz	
A29		dvojton		641Hz, 980Hz	0,25s; 0,25s
A30		dvojton		505Hz, 606Hz	0,25s; 0,25s
A31		dvojton		794Hz, 952Hz	0,25s; 0,25s
A32		dvojton		1,18kHz, 790Hz	0,5s ; 0,5s

Nastavenie DIP prepínača (svetlo)

	Poloha prepínača		Počet pulzov, šírka pulzu, šírka medzery, dĺžka celého cyklu[ms], ktoré LED budú aktívne	Druh svetelného efektu
S01			1.30. 30. 60	impulzné blikanie (silná intenzita)
S02			1, 300, 300, 600, 0x0E	jednoduché blikanie (silná intenzita)
S03			1, 40, 300, 340, 0x0E	jednoduché blikanie (silná intenzita)
S04			7, 30, 30, 430, 0x0E	impulzné blikanie s medzerou (silná intenzita)
S05			1, 30, R1, R1 + 30, 0x0E	blíkavanie s náhodnou medzerou (silná intenzita)
S06			2, 50, 200, 750, 0x0E	impulzné blikanie s medzerou (silná intenzita)
S07			1, 50, 1500, 1550, 0x0E	jednoduché blikanie s dlhou medzerou (silná int.)
S08			1, 50, 750, 800, 0x0E	jednoduché blikanie s dlhou medzerou (silná int.)
S09			všetky trvalo svietia	trvalé svietenie (silná intenzita)
S10			1, 300, 300, 600, 0x05	jednoduché blikanie (slabá intenzita)
S11			1, 40, 300, 340, 0x05	jednoduché blikanie (slabá intenzita)
S12			7, 30, 30, 430, 0x05	impulzné blikanie s medzerou (slabá intenzita)
S13			1, 30, R1, R1 + 30, 0x05	blíkavanie s náhodnou medzerou (slabá intenzita)
S14			2, 50, 200, 750, 0x05	impulzné blikanie s medzerou (slabá intenzita)
S15			1, 50, 1500, 1550, 0x05	jednoduché blikanie s dlhou medzerou (slabá int.)
S16			1, 50, 750, 800, 0x05	jednoduché blikanie s dlhou medzerou (slabá int.)
S17			dve led (1 a 3) trvalo svietia	trvalé svietenie (slabá intenzita)
S18			1, 300, 1, 301, LED_bar_cnt	rotačný efekt
S19			1, 150, 1, 151, LED_bar_cnt	rotačný efekt
S20			1, 100, 1, 101, LED_bar_cnt	rotačný efekt
S21			1, 75, 1, 75, LED_bar_cnt	rotačný efekt
S22			zhodné s S01 1.30. 30. 60	zhodné s S01 impulzné blikanie (silná intenzita)
S23				
S24				
S25				
S26				
S27				
S28				
S29				
S30				
S31				
S32	