

Mini Horns Sirens Buzzer / Horn 585

Signal horn WM Contin. tone 24VAC/DC GY

Part No.: 585.000.75

**MECHANICAL DATA**

Length	91 mm
Width	83 mm
Height	84 mm
Diameter	83 mm
Materials	PC PC/ABS
Housing colour	Grey
Protection category	IP65
Connection	Screw terminals
cross-sectional area maximum	1,50mm ² / 16AWG
Cable entry	Membrane grommet
Cable entry minimum	d = 1 mm
Cable entry maximum	d = 9 mm
Tension relief	Pull-out protection
Type of fixing	Wall mounting
Service life optical	5,000 h minimum
Acoustic service life	5,000 h minimum
Working temperature minimum	-20°C
Working temperature maximum	+50°C
Weight with packaging	143 g
Product weight	109 g

ELECTRICAL DATA

Operating voltage	24V
Operating voltage type	AC/DC
Operating voltage type	50Hz
Operating voltage tolerance	+/- 10%
Rated operational voltage	24 VDC
Rated operational current	80 mA
Rated inrush current	500 mA
Protection class	Protection class 2
Pollution degree	3

ACUSTICAL DATA

Volume/dB(max) at 1m distance	98,0 dB dB(A)
Acoustic signal image	Continuous tone
Audio frequency	110 Hz



For additional installation and mounting information, refer to the appropriate user guide at www.werma.com. This printed copy is for information only and is subject to alteration.

Mini Horns Sirens Buzzer / Horn 585

Signal horn WM Contin. tone 24VAC/DC GY

DRAWING

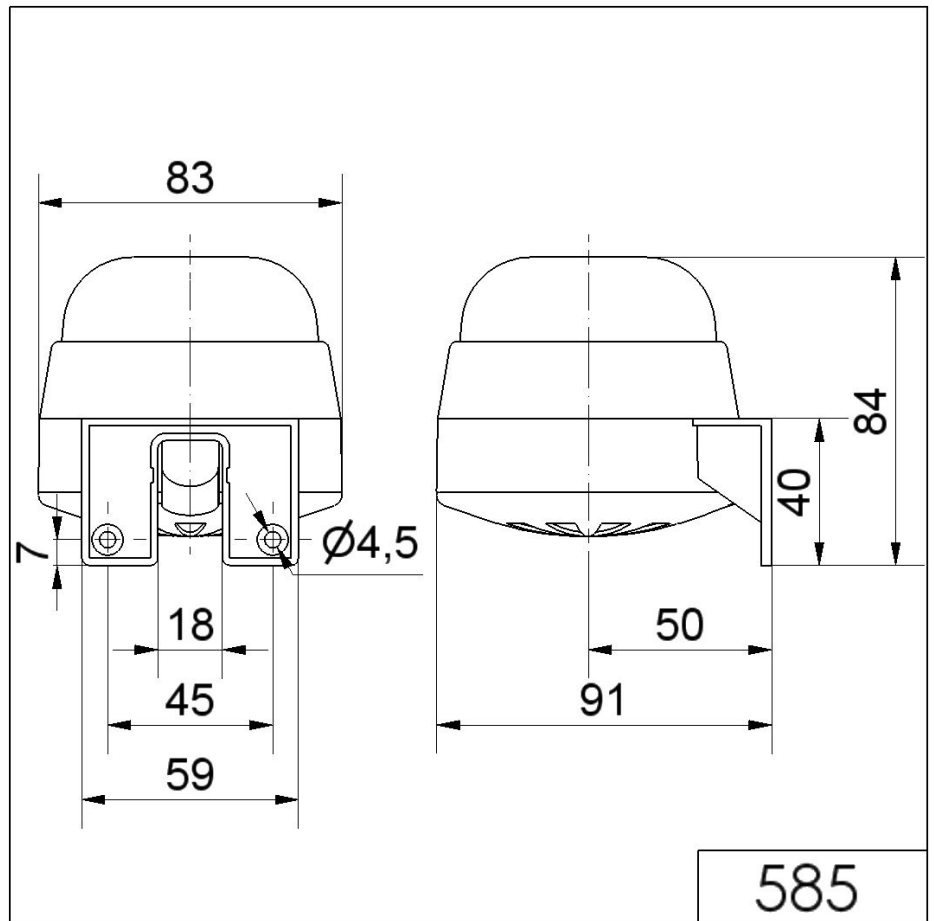

For additional installation and mounting information, refer to the appropriate user guide at www.werma.com. This printed copy is for information only and is subject to alteration.