

Mini free-standing Beacons / LED-Permanent Light 224

LED Perm. Beacon WM 115VAC GN

Part No.: 224.200.67

**MECHANICAL DATA**

Height	105 mm
Diameter	75 mm
Materials	PA-GF PC PC/ABS
Dome colour	Green
Housing colour	Black
Protection category	IP65
Connection	Spring-type terminal
cross-sectional area maximum	2,50mm ² / 14AWG
Cable entry	Screwed cable gland
Cable entry minimum	d = 3 mm
Cable entry maximum	d = 6 mm
Tension relief	Present (conforms to VDI)
Type of fixing	Wall mounting
Service life optical	100,000 h maximum
Working temperature minimum	-20°C
Working temperature maximum	+50°C
UL Type Rating	Type 12
Weight with packaging	142 g
Product weight	142 g

ELECTRICAL DATA

Operating voltage	115V
Operating voltage type	AC
Operating voltage type	60Hz
Operating voltage tolerance	+/- 10%
Rated operational voltage	115 VAC
Rated operational current	25 mA
Rated inrush current	500 mA
Protection class	Protection class 2
Pollution degree	3
Overvoltage category	II
Isolation voltage	Ui = 250V; Uimp = 2.500V

OPTICAL DATA

Light source	LED
Light colour	Green
Optical signal image	Permanent



For additional installation and mounting information, refer to the appropriate user guide at www.werma.com. This printed copy is for information only and is subject to alteration.

Mini free-standing Beacons / LED-Permanent Light 224
LED Perm. Beacon WM 115VAC GN

DRAWING

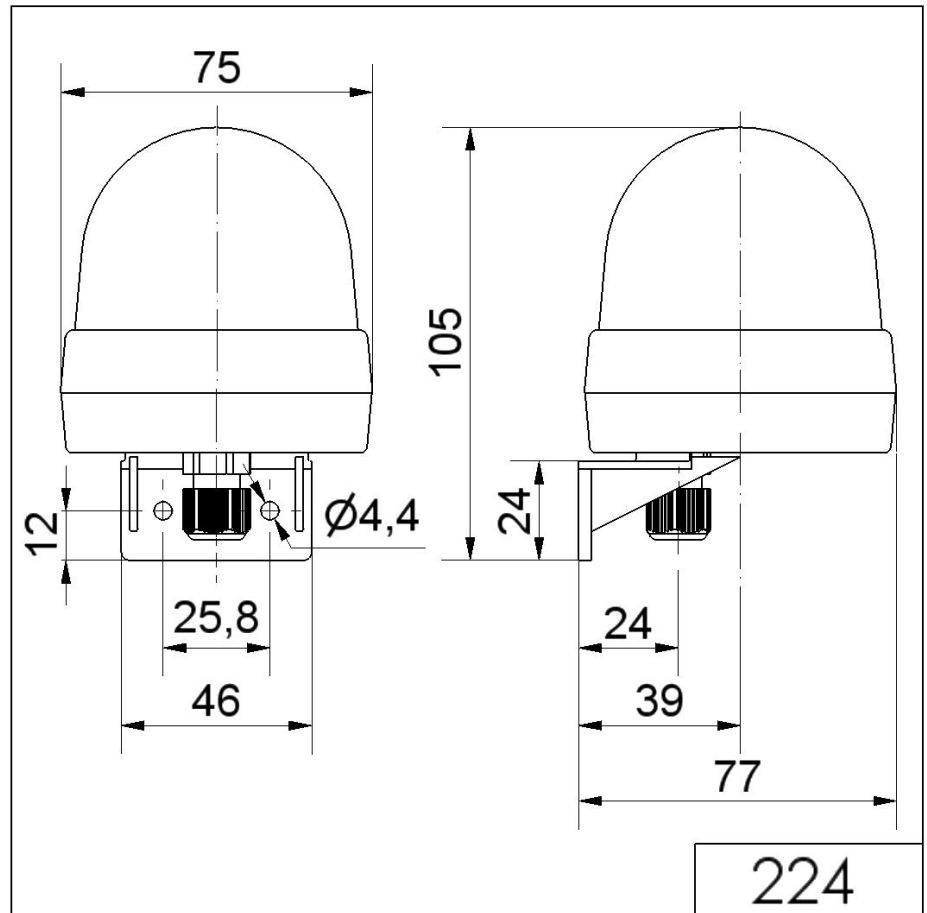

For additional installation and mounting information, refer to the appropriate user guide at www.werma.com. This printed copy is for information only and is subject to alteration.